

**ComfortStar®**

# INSTALLATION INSTRUCTIONS

PACKAGED HEAT PUMP  
FEATURING R-410A  
13.4 SEER2 CPH SERIES - (2-5Tons)

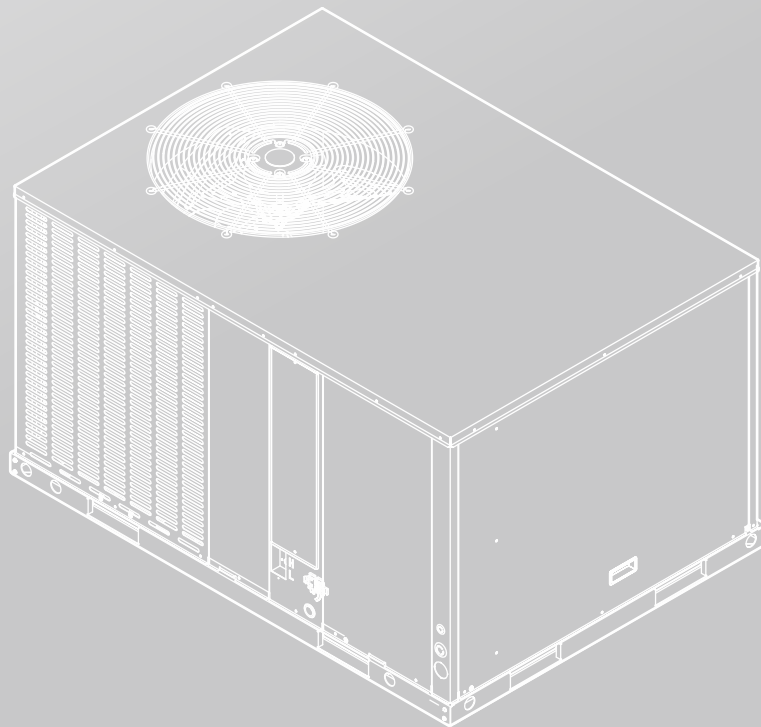

Thank you very much for purchasing our product,  
Before using your unit , please read this manual carefully and keep it for future reference.  
The figure shown in this manual is for reference only and may be slightly different from the actual product.





## RECOGNIZE THIS SYMBOL AS AN INDICATION OF IMPORTANT SAFETY INFORMATION

### WARNING

These instructions are intended as an aid to qualified, licensed service personnel for proper installation, adjustment and operation of this unit. Read these instructions thoroughly before attempting installation or operation. Failure to follow these instructions may result in improper installation, adjustment, service or maintenance possibly resulting in fire, electrical shock, property damage, personal injury or death.

# CONTENTS

## 1 SAFETY

- 1.1 Inspection ..... 02
- 1.2 Limitations ..... 02

## 2 INSTALLATION

- 2.1 Pre-Installation ..... 02
- 2.2 Clearance ..... 02
- 2.3 Rigging and Handling ..... 02

## 3 DUCTWORK ..... 08

## 4 CONDENSATE DRAIN CONNECTION

- 4.1 Install Drain Pipe ..... 08

## 5 FILTERS ..... 08

## 6 ELECTRICAL WIRING

- 6.1 Power Wiring ..... 09
- 6.2 Grounding ..... 09
- 6.3 Control Wiring ..... 09

## 7 AIRFLOW PERFORMANCE

- 7.1 Airflow Performance Data ..... 12

## 8 SYSTEM OPERATION

- 8.1 Compressor Crankcase Heater ..... 20
- 8.2 Protection ..... 20
- 8.3 Defrost Mode Instruction ..... 20
- 8.4 Thermostat Signals ..... 21

## 9 OPERATION CHECK-UP ..... 22

## 10 TROUBLE SHOOTING

- 10.1 Fault Code of Motor Driver Module ..... 22
- 10.2 Fault Code of Main Control Module ..... 22
- 10.3 Troubleshooting Table ..... 23

This document is customer property and is to remain with this unit.

These instructions do not cover all the different variations of systems nor does it provide for every possible contingency to be met in connection with installation.

All phases of this installation must comply with NATIONAL, STATE and LOCAL CODES. If additional information is required please contact your local distributor.

## 1 SAFETY

When you see the symbols below on the labels or in the manuals, be alert to the potential or immediate hazards of personal injury, property and/or product damage. It is the owner's or installer's responsibility to comply with all safety instructions and information accompanying these symbols.



**WARNING:** This is a safety alert symbol indicating a potential hazardous situation, which could result in personal injury, property and/or product damage or death.



**CAUTION:** This is a safety alert symbol indicating a potential hazardous situation, which could result in moderate personal injury, property and/or product damage.

### WARNING

These instructions are intended as an aid to qualified, licensed service personnel for proper installation, adjustment and operation of this unit. Read these instructions thoroughly before attempting installation or operation.

Failure to follow these instructions may result in improper installation, adjustment, service or maintenance possibly resulting in fire, electrical shock, property damage, personal injury or death.

### WARNING

The manufacturer's warranty does not cover any damage or defect to the heat pump caused by the attachment or use of any components, accessories or devices (other than those authorized by the manufacturer) into, onto or in conjunction with the heat pump. You should be aware that the use of unauthorized components, accessories or devices may adversely affect the operation of the heat pump and may also endanger life and property. The manufacturer disclaims any responsibility for such loss or injury resulting from the use of such unauthorized components, accessories or devices.

### WARNING

Disconnect all power to the unit before starting maintenance. Failure to do so can result in severe electrical shock or death.

### WARNING

Do not, under any circumstances, connect return ductwork to any other heat producing device such as a fireplace insert, stove, etc. Unauthorized use of such devices may result in fire, carbon monoxide poisoning, explosion, property damage, severe personal injury or death.

### WARNING

The unit must be permanently grounded. A grounding lug is provided. Failure to ground this unit can result in fire or electrical shock causing property damage, severe personal injury or death.

### WARNING

Only electric heater kits supplied by this manufacturer as described in this publication have been designed, tested, and evaluated by a nationally recognized safety testing agency for use with this unit. Use of any other manufactured electric heaters installed within this unit may cause hazardous conditions resulting in property damage, fire, body injury or death.

### WARNING

Proposition 65: This appliance contains fiberglass insulation. Respirable particles of fiberglass are known to the state of California to cause cancer.

### CAUTION

Only use this unit in well-ventilated spaces and ensure that there are no obstructions that could impede the airflow into and out of the unit. Do not use this unit in the following locations:

- Locations with mineral oil.
- Locations with saline atmospheres, such as seaside locations.
- Locations with sulphurous atmospheres, such as near natural hot springs.
- Where high voltage electricity is present, such as in certain industrial locations.
- On vehicles or vessels, such as trucks or ferry boats.
- Where exposure to oily or very humid air may occur, such as kitchens.
- In proximity to sources of electromagnetic radiation, such as high-frequency transmitters or other high strength radiation devices.

## CAUTION

A manufactured (mobile) home installation must conform with the Manufactured Home Construction and Safety Standard, Title 24 CFR, Part 3280, or when this Standard is not applicable, the Standard for Manufactured Home Installations (Manufactured Home Sites, Communities and Set-Ups), ANSI/NCS A225.1, and/or MH Series Mobile Homes, CAN/CSA Z240.

### 1.1 Inspection

As soon as unit is received, it should be inspected and noted for possible shipping damage during transportation. It is carrier's responsibility to cover the cost of shipping damage. Manufacturer or distributor will not accept the claims from dealer for any transportation damage.

### 1.2 Limitations

Refer to Fig. 2-2, 2-3, 2-4, 2-5 for unit physical data and to Table 6-1 & 6-2 for electrical data. If components are to be added to a unit they must meet local codes, they are to be installed at the dealer's and /or the customer's expense.

Size of unit for proposed installation should be based on heat loss / heat gain calculations made in accordance with industry recognized procedures identified by the Air Conditioning Contractors of America.

## 2 INSTALLATION

### 2.1 Pre-Installation

Before installation, carefully check the following:

1. Unit should be installed in accordance with national and local safety codes, including but not limit to ANSI/NFPA No. 70 or Canadian Electrical Code Part 1, C22.1, local plumbing and wastewater codes and any other applicable codes.
2. For rooftop installation, be sure the structure has enough strength to support the weight of unit. Unit should be installed on roof curb and leveled.
3. For ground level installation, a level slab should be used.
4. Condenser airflow should not be restricted.
5. On applications when a roof curb is used, the unit must be positioned on the curb so the front of the unit is tight against the curb.

### 2.2 Clearance

All units require certain clearance for proper operation and service. Refer to Table 2-1 for the clearances required for construction, servicing and proper unit operation.

### 2.3 Rigging and Handing

Exercise care when moving the unit. Do not remove any packaging until the unit is near the place of installation. Rig the unit by attaching chain or cable slings to the lifting holes provided in the base rails. Spreader bars, whose length exceeds the largest dimension across the unit, MUST be used across the top of the unit.

## CAUTION

Before lifting, make sure the unit weight is distributed equally on the rigging cables so it will lift evenly.

Units may be moved or lifted with a forklift. Slotted openings in the base rails are provided for this purpose.

## CAUTION

All panels must be secured in place when the unit is lifted.

The condenser coils should be protected from rigging cable damage with plywood or other suitable material.

## WARNING

Check the electric wire, water and gas pipeline layout inside the wall, floor and ceiling before installation. Do not implement drilling unless confirm safety with the user, especially for the hidden power wire. An electroprobe can be used to test whether a wire is passing by at the drilling location, to prevent physical injury or death caused by insulation broken cords.

## WARNING

Check the power supply before installation. Ensure that the power supply must be reliably grounded following local, state and National Electrical Codes. If not, for example, if the ground wire is detected charged, installation is prohibited before it is rectified. Otherwise, there is a risk of fire and electric shock, causing physical injury or death.

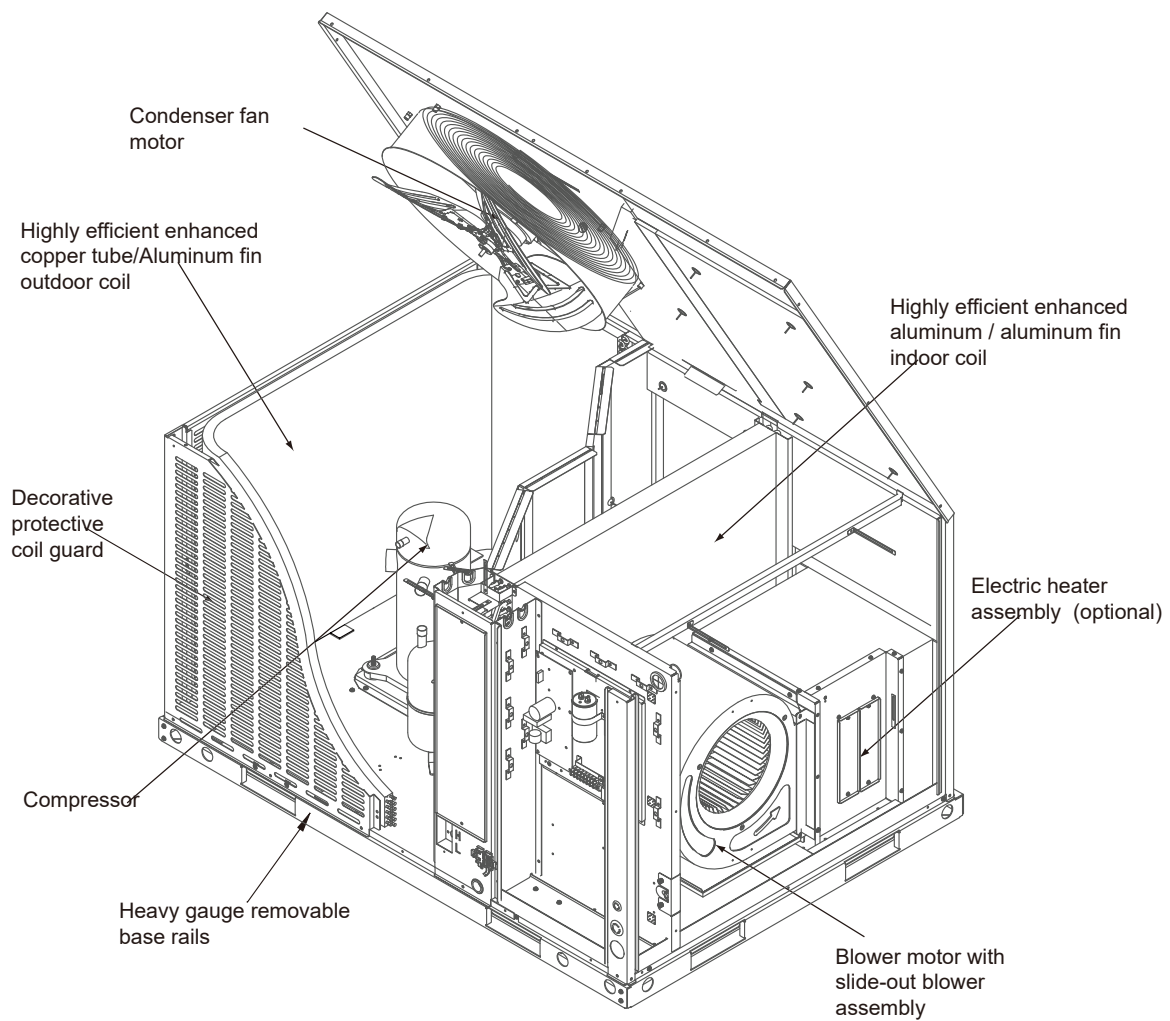

**Fig. 2-1 Component Location**

\* The above figure for reference purpose only.

Unit size:024, 030, 036

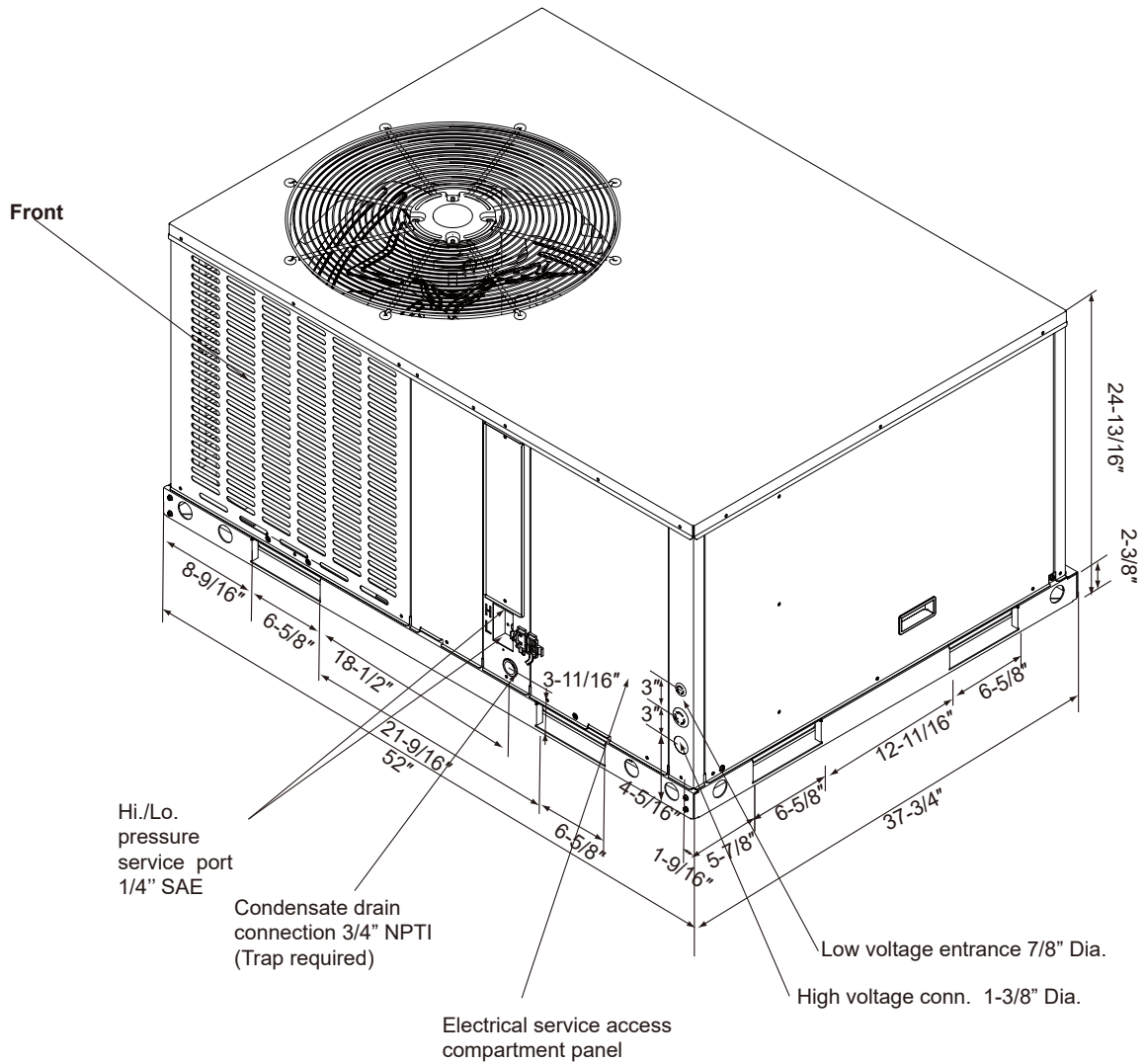

Fig. 2-2 Unit Dimensions

\* The above figure for reference purpose only.

Unit size:024, 030, 036

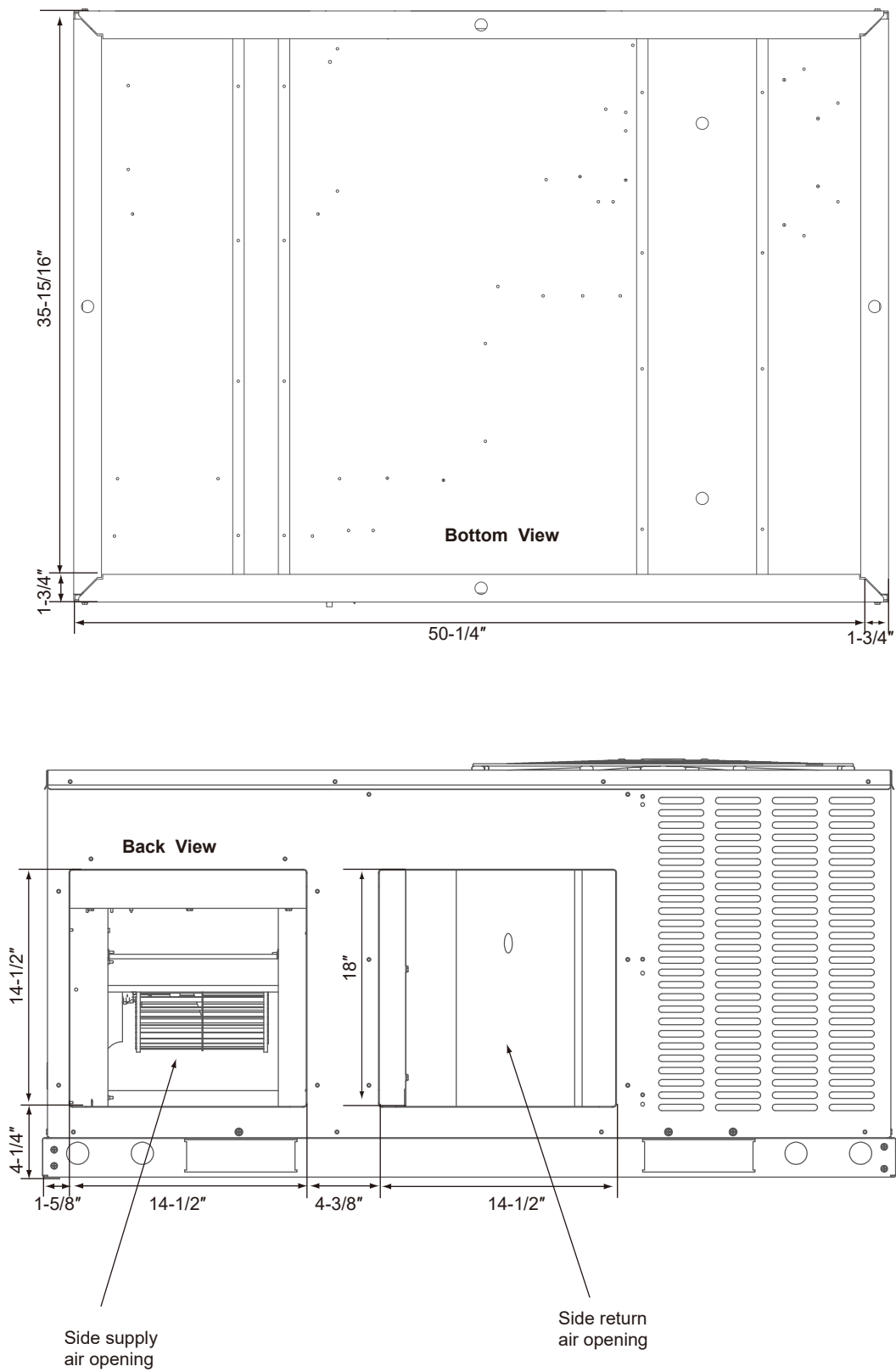

Fig. 2-3 Dimensions Back and Bottom

\* The above figure for reference purpose only.

Unit size:042, 048, 060

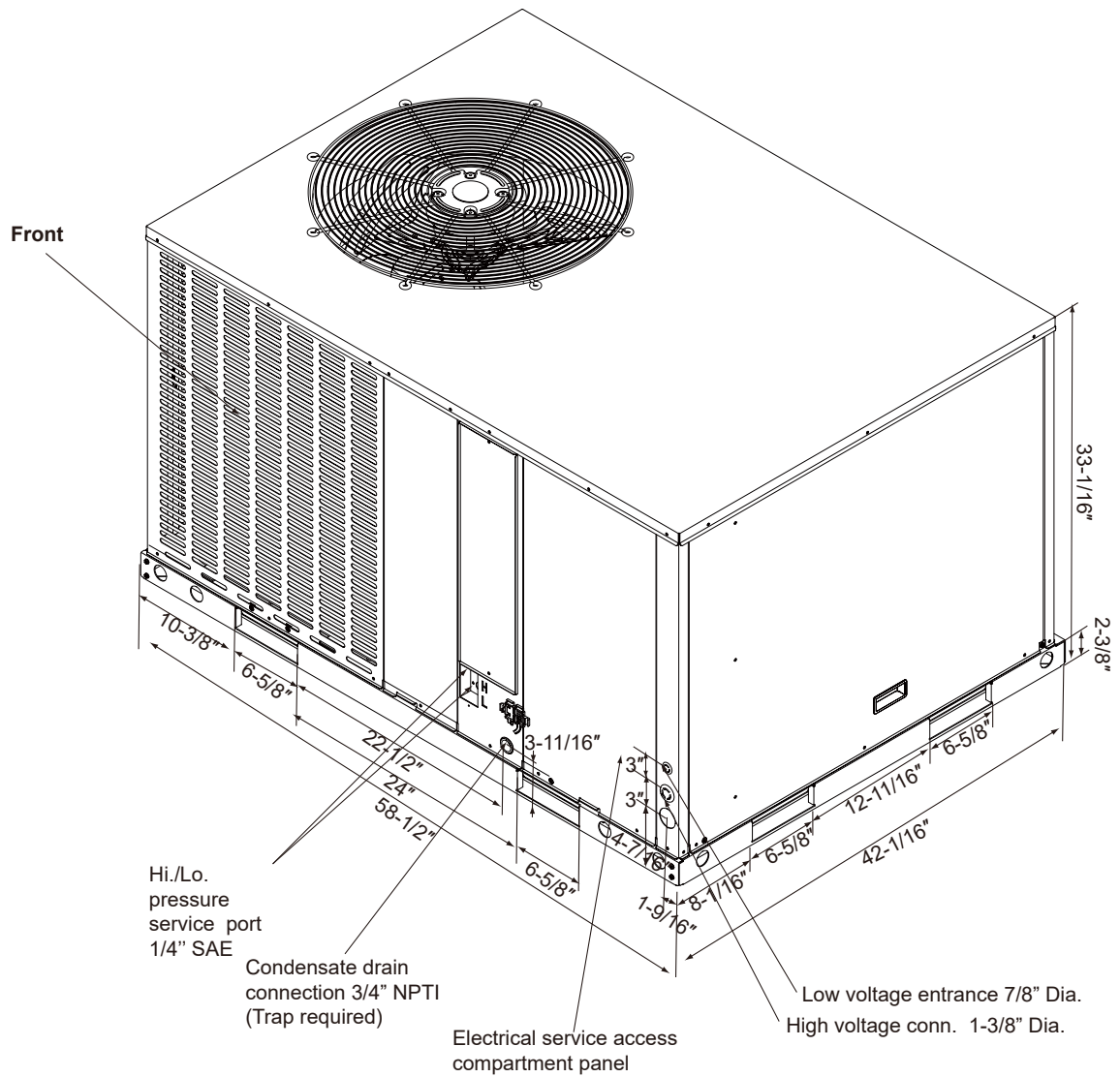

Fig. 2-4 Unit Dimensions

\* The above figure for reference purpose only.



Unit size:042, 048, 060

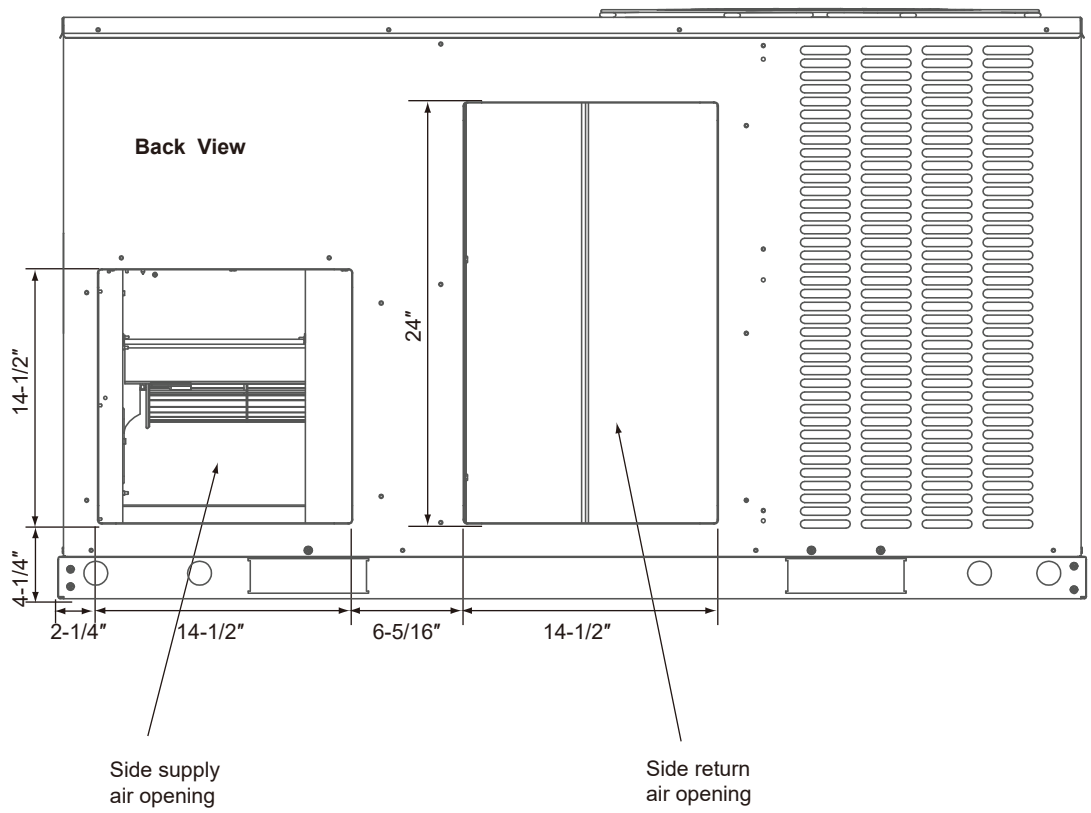
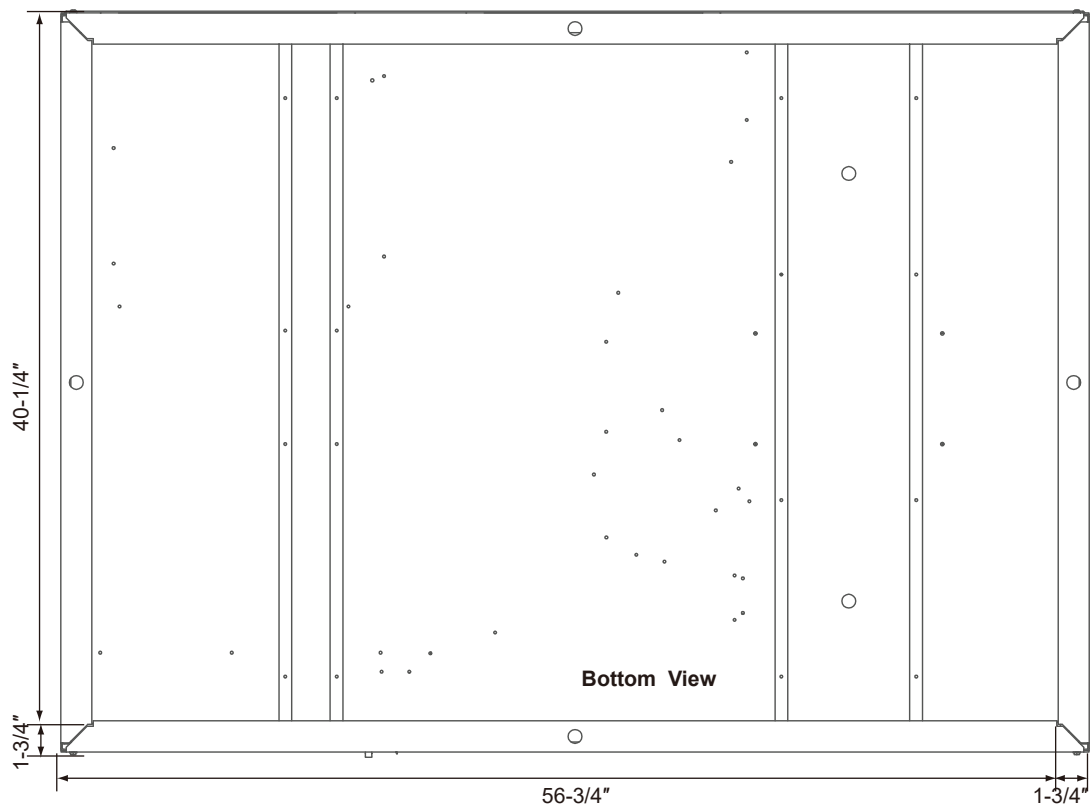

Fig. 2-5 Dimensions Back and Bottom

\* The above figure for reference purpose only.

Table 2-1: Unit Clearance

| Direction        | Distance (in.)  | Direction           | Distance (in.) |
|------------------|-----------------|---------------------|----------------|
| Top <sup>1</sup> | 60              | Right               | 30             |
| Front            | 30              | Left                | 24             |
| Rear             | 18 <sup>2</sup> | Bottom <sup>3</sup> | 0              |

Duct clearance: 1 inch clearance for all sides of air supply duct.

1. Units must be installed outdoors. Over hanging structure or shrubs should not obscure condenser air discharge outlet.
2. The minimum clearance without economizer/fresh air damper. For distance with economizer/fresh air damper, please refer to the installation instructions provided with the accessory.
3. Units may be installed on combustible floors made from wood or class A, B or C roof covering materials.

#### NOTE

For units applied with a roof curb, the minimum clearance may be reduced from 1 inch to 1/2 inch between combustible roof curb material and this supply air duct.

#### NOTE

A unit with electric heaters with an inlet or outlet duct that penetrates the building structure supporting the unit shall be provided with a mounting base of noncombustible material so designed that, after the unit is installed, there will be no open passages through the supporting structure that would permit flame or hot gases from a fire originating in the space below the supporting structure to travel to the space above that structure. If the unit is intended to be installed on a supporting structure of combustible material, the base shall be so designed that the required clearance will be maintained between the supporting structure and the unit, plenum, and attached duct. Spacers necessary to provide required clearances shall be attached to the unit mounting base, and shall extend not less than 76 mm (3 in.) below the upper surface of the supporting structure, except that, in a unit designed for use only in a mobile home, the distance shall be not less than 19 mm (3/4 in.).

### 3 DUCTWORK

Ductwork should be sized and installed by the installing contractor in accordance with the Manual D from the Air Conditioning Contractors of America, and all national, state and local codes.

#### NOTE

On ductwork exposed to outside air space, use at least 2" of insulation and a vapor barrier. Flexible joint may be used to reduce noise.

A closed return duct system shall be used. This shall not preclude use of economizers or ventilation air intake. Flexible joints may be used in the supply and return duct work to minimize the transmission of noise.

#### CAUTION

When fastening duct work to the side duct flanges on the unit, insert the screws through the duct flanges only. DO NOT insert the screws through the casing. Outdoor duct work must be insulated and waterproofed.

#### NOTE

Be sure to note supply and return openings. Refer to Fig. 2-3 and 2-5 for information concerning supply and return air duct openings.

## 4 CONDENSATE DRAIN CONNECTION

Consult local codes for special requirements.

To provide extra protection from water damage, install an additional drain pan, provided by installer, under the entire unit with a separate drain line.

Manufacturer will not be responsible for any damages due to the failure to follow these requirements.

### 4.1 Install Drain Pipe

1. Use the provided female NPT threaded fitting for outside connection and make sure that drain holes are not blocked.
2. Insulation may be needed for drain line to prevent sweating.
3. Drain pan has two drain connections on each side to provide flexibility of connection and drainage. Make sure proper pitch and plugging if second connection is not used.
4. Use a sealing compound on male pipe threads. Install the condensate drain line (NPT) to spill into an open drain.
5. Ensure a trap is included in the condensate drain line.

## 5 FILTERS

Units are shipped without a filter or filter racks. It is the responsibility of the installer to secure a filter in the return air ductwork or install a filter/frame Kit.

Filter must always be used and must be kept clean. Dirty filters may cause insufficient air delivery, decreasing unit efficiency and increasing operation costs and wear-and tear on the unit and controls.

Filters should be checked monthly; this is especially important since this unit is used for both heating and cooling.

## 6 ELECTRICAL WIRING

Field wiring must comply with the National Electric Code (NEC) or Canadian Electrical Code (CEC) and any applicable local ordinance.

### ⚠ WARNING

Disconnect all power to unit before installing or servicing. More than one disconnect switch may be required to de-energize the equipment. Hazardous voltage can cause severe personal injury or death.

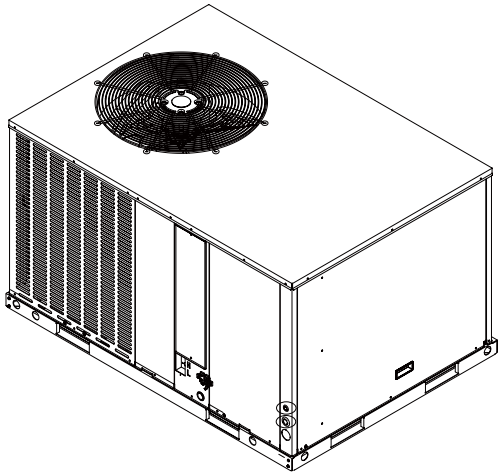

When installing power cables (in the middle) and signal cables (in the top) of the whole device, first remove the cable running apron, install the bushing, and finally install the power cables.

### 6.1 Power Wiring

1. Proper electrical power should be available at unit. Voltage tolerance should not be over 10% from rating voltage.
  2. If any of the wire must be replaced, replacement wire must be the same type as shown in nameplate, wiring diagram and electrical data sheet.
  3. Install a branch circuit disconnect of adequate size to handle starting current, located within sight of, and readily accessible to the unit.
  4. **ELECTRIC HEATER** - If the Electric Heater is installed, unit may be equipped with 30~60A. circuit breakers or fuse. These breaker(s) protect the internal wiring in the event of a short circuit and serve as a disconnect. Circuit breakers installed within the unit do not provide over-current protection of the supply wiring and therefore may be sized larger than the branch circuit protection.
    - Supply circuit power wiring must be 221 °F minimum copper conductors only.
- See Electrical Data in this section for ampacity, wire size and circuit protector requirements. Supply circuit protective devices may be either fuses or "HACR" type circuit breakers.
- 1-3/8" knockouts inside the cabinet are provided for connection of power wiring to electric heater.

- Power wiring is connected to the power terminal block in unit electric cabinet.
- See Electrical Heater Installation Instruction for details.

### 6.2 Grounding

### ⚠ WARNING

The unit must be permanently grounded. Failure to do so can result in electrical shock causing personal injury or death.

- The unit must be electrically grounded in accordance with local codes or the national electric code.
- Grounding may be accomplished by attaching ground wire(s) to ground lug(s) provided in the unit wiring compartment.

### 6.3 Control Wiring

**IMPORTANT:** Class 2 low voltage control wiring should not be run in conduit with main power wiring and must be separated from power wiring, unless class 1 wire of proper voltage rating is used.

- Low voltage control wiring should be 18 AWG color-coded. For lengths longer than 50 ft, 16 AWG wire should be used.
- Two 7/8" holes can be used for control wires going into the unit, one on left side and one at the bottom.
- Make sure, after installation, separation of control wiring and power wiring has been maintained.

**Thermostat** should be mounted on an inside wall about 58" from floor and will not be affected by unconditioned air, sun and/or heat exposure. Follow the instruction carefully because there are many wiring requirements. See Fig. 6-1 ~ 2, Table 6-1.

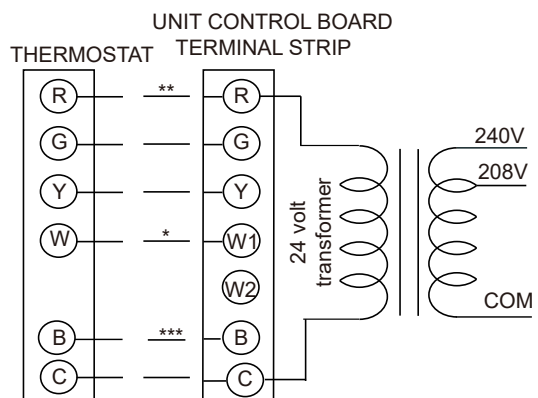

**Fig. 6-1 Typical Field Control Wiring Diagram**

- \*\*\* B wire be used with heat pump system only, reversing valve energizes at the heating mode, and cut off at the cooling mode.
- \*\* Minimum wire size of 18 AWG wire should be used for all field installed 24 volt wire.
- \* Only required on units with supplemental electric heat.



Table 6-2: 13.4 SEER2 Physical Data

| Component                         | Models                     | Models       | Models       | Models       | Models       | Models       |
|-----------------------------------|----------------------------|--------------|--------------|--------------|--------------|--------------|
|                                   | 24                         | 30           | 36           | 42           | 48           | 60           |
| Nominal Tonnage                   | 2                          | 2.5          | 3            | 3.5          | 4            | 5            |
| <b>ARI COOLING PERFORMANCE</b>    |                            |              |              |              |              |              |
| 95°F Capacity rating (Btu/h)      | 22800                      | 28200        | 34200        | 40500        | 46500        | 57000        |
| SEER2                             | 13.4                       | 13.4         | 13.4         | 13.4         | 13.4         | 13.4         |
| Nominal CFM                       | 840                        | 1060         | 1200         | 1450         | 1450         | 1700         |
| System power (kW)                 | 2.07                       | 2.56         | 3.1          | 3.68         | 4.18         | 5.18         |
| Refrigerant type                  | R410a                      | R410a        | R410a        | R410a        | R410a        | R410a        |
| Refrigerant charge (lb-oz)        | 5-13                       | 5-12         | 4-13         | 6-10         | 6-10         | 9-4          |
| <b>ARI HEATING PERFORMANCE</b>    |                            |              |              |              |              |              |
| 47°F Capacity rating (Btu/h)      | 22400                      | 28200        | 34200        | 40500        | 47000        | 57000        |
| System power (kW)                 | 1.88                       | 2.36         | 2.86         | 3.35         | 3.85         | 4.77         |
| HSPF2 (BTU/Watts-hr.)             | 6.7                        | 6.7          | 6.7          | 6.7          | 6.7          | 6.7          |
| <b>DIMENSIONS (Inches)</b>        |                            |              |              |              |              |              |
| Length                            | 52                         | 52           | 52           | 58-1/2       | 58-1/2       | 58-1/2       |
| Width                             | 37-3/4                     | 37-3/4       | 37-3/4       | 42-1/16      | 42-1/16      | 42-1/16      |
| Height                            | 24-13/16                   | 24-13/16     | 24-13/16     | 33-1/16      | 33-1/16      | 33-1/16      |
| OPERATING WT. (lbs)               | 324                        | 325          | 342          | 448          | 442          | 457          |
| <b>COMPRESSORS</b>                |                            |              |              |              |              |              |
| Type                              | Rotary                     | Rotary       | Scroll 1-spd | Scroll 1-spd | Scroll 1-spd | Scroll 1-spd |
| Quantity                          | 1                          | 1            | 1            | 1            | 1            | 1            |
| <b>CONDENSER COIL DATA</b>        |                            |              |              |              |              |              |
| Face area (Sq. Ft)                | 9.8                        | 9.8          | 9.44         | 15.54        | 15.54        | 15.3         |
| Rows                              | 2                          | 2            | 2.5          | 2            | 2            | 2.7          |
| Fins per inch                     | 20                         | 20           | 21           | 21           | 21           | 20           |
| Tube diameter(inch)               | 9/32                       | 9/32         | 3/16         | 3/16         | 3/16         | 9/32         |
| Tube type                         | innergroove copper tube    |              |              |              |              |              |
| Circuitry type                    | interlaced                 | interlaced   | interlaced   | interlaced   | interlaced   | interlaced   |
| <b>EVAPORATOR COIL DATA</b>       |                            |              |              |              |              |              |
| Face area (Sq. Ft)                | 3.63                       | 3.63         | 3.63         | 6.43         | 6.43         | 6.43         |
| Rows                              | 4                          | 4            | 4            | 4            | 4            | 4            |
| Fins per inch                     | 17                         | 17           | 17           | 17           | 17           | 17           |
| Tube diameter(inch)               | 9/32                       | 9/32         | 9/32         | 9/32         | 9/32         | 9/32         |
| Tube type                         | innergroove aluminium tube |              |              |              |              |              |
| Circuitry type                    | interlaced                 | interlaced   | interlaced   | interlaced   | interlaced   | interlaced   |
| Refrigerant control               | Orifice                    | Orifice      | Orifice      | Orifice      | Orifice      | Orifice      |
| <b>CONDENSER FAN DATA</b>         |                            |              |              |              |              |              |
| Fan diameter (inch)               | 22                         | 22           | 22           | 23-5/8       | 23-5/8       | 23-5/8       |
| Type                              | Prop                       | Prop         | Prop         | Prop         | Prop         | Prop         |
| Drive type                        | Direct/ECM                 | Direct/ECM   | Direct/ECM   | Direct/ECM   | Direct/ECM   | Direct/ECM   |
| No. speeds                        | 10                         | 10           | 10           | 10           | 10           | 10           |
| Number of motors                  | 1                          | 1            | 1            | 1            | 1            | 1            |
| Motor HP each                     | 1/4                        | 1/4          | 1/4          | 1/4          | 1/4          | 1/4          |
| RPM                               | 200~800                    | 200~980      | 200~980      | 200~980      | 200~980      | 200~980      |
| Nominal total CFM                 | 2300                       | 2850         | 2500         | 3480         | 3480         | 3400         |
| <b>DIRECT DRIVE EVAP FAN DATA</b> |                            |              |              |              |              |              |
| Quantity                          | 1                          | 1            | 1            | 1            | 1            | 1            |
| Fan Size (Inch)                   | 10×9                       | 10×9         | 10×9         | 11×10-5/8    | 11×10-5/8    | 11×10-5/8    |
| Type                              | Centrifugal                | Centrifugal  | Centrifugal  | Centrifugal  | Centrifugal  | Centrifugal  |
| No. speeds                        | 1                          | 1            | 1            | 1            | 1            | 1            |
| Motor HP each                     | 1/4                        | 1/2          | 1/2          | 3/4          | 3/4          | 3/4          |
| RPM                               | 1050                       | 1050         | 1050         | 1050         | 1050         | 1050         |
| Motor frame size                  | 48                         | 48           | 48           | 48           | 48           | 48           |
| <b>Electrical Data</b>            |                            |              |              |              |              |              |
| Voltage-Phase-Hz                  | 208/230-1-60               | 208/230-1-60 | 208/230-1-60 | 208/230-1-60 | 208/230-1-60 | 208/230-1-60 |
| Min / Max Volts                   | 188/ 253                   | 188/ 253     | 188/ 253     | 188/ 253     | 188/ 253     | 188/ 253     |
| <b>RETURN-AIR FILTERS</b>         |                            |              |              |              |              |              |
| THROWAWAY (in.)(mm)               | 24x30x1                    | 24x30x1      | 24x30x1      | 24x36x1      | 24x36x1      | 24x36x1      |
|                                   | 610x762x25                 | 610x762x25   | 610x762x25   | 610x914x25   | 610x914x25   | 610x914x25   |

## 7 AIRFLOW PERFORMANCE

Airflow performance data is based on cooling performance with a coil and no filter in place. Use this performance table for appropriate unit size, external static applied to unit and allow operation within the minimum and maximum limits shown in table below for both cooling and electric heat operation.

### 7.1 Airflow Performance Data

Table 7-1 Duct Application(208V)

| Model Number | Motor Speed              |       | SCFM                                      |          |          |          |          |          |          |          |          |
|--------------|--------------------------|-------|---|----------|----------|----------|----------|----------|----------|----------|----------|
|              |                          |       | External Static Pressure-Inches W.C.[kPa] |          |          |          |          |          |          |          |          |
|              |                          |       | 0[0]                                      | 0.1[.02] | 0.2[.05] | 0.3[.07] | 0.4[.10] | 0.5[.12] | 0.6[.15] | 0.7[.17] | 0.8[.20] |
| 24           | Low-Tap(1)               | SCFM  | 787                                       | 744      | 691      | 643      | /        | /        | /        | /        | /        |
|              |                          | Watts | 187                                       | 185      | 182      | 152      | /        | /        | /        | /        | /        |
|              |                          | Amps  | 0.98                                      | 0.77     | 0.75     | 0.73     | /        | /        | /        | /        | /        |
|              | Mid-Tap(2)<br>(Factory)  | SCFM  | /   | /        | /        | 882      | 828      | 751      | 698      | /        | /        |
|              |                          | Watts | /   | /        | /        | 269      | 262      | 253      | 246      | /        | /        |
|              |                          | Amps  | /   | /        | /        | 1.37     | 1.34     | 1.31     | 1.27     | /        | /        |
|              | High-Tap(3)              | SCFM  | /   | /        | /        | /        | /        | 964      | 896      | 759      | 621      |
|              |                          | Watts | /   | /        | /        | /        | /        | 360      | 330      | 307      | 276      |
|              |                          | Amps  | /   | /        | /        | /        | /        | 1.78     | 1.71     | 1.64     | 1.57     |
| 30           | Low-Tap(1)               | SCFM  | 956                                       | 908      | 860      | 815      | 771      | /        | /        | /        | /        |
|              |                          | Watts | 1.2                                       | 1.27     | 1.35     | 1.44     | 1.52     | /        | /        | /        | /        |
|              |                          | Amps  | 114                                       | 122      | 131      | 141      | 151      | /        | /        | /        | /        |
|              | Mid-Tap(2)               | SCFM  | 1082                                      | 1039     | 996      | 958      | 917      | 881      | 831      | 780      | /        |
|              |                          | Watts | 1.54                                      | 1.63     | 1.73     | 1.82     | 1.92     | 2.01     | 2.12     | 2.21     | /        |
|              |                          | Amps  | 153                                       | 164      | 175      | 186      | 119      | 209      | 221      | 231      | /        |
|              | High-Tap(3)<br>(Factory) | SCFM  | /   | /        | /        | 1102     | 1066     | 1031     | 998      | 964      | 916      |
|              |                          | Watts | /   | /        | /        | 2.34     | 2.46     | 2.56     | 2.66     | 2.76     | 2.88     |
|              |                          | Amps  | /   | /        | /        | 248      | 261      | 274      | 286      | 297      | 312      |
| 36           | Low-Tap(2)               | SCFM  | 1082                                      | 1039     | 996      | 958      | 917      | /        | /        | /        | /        |
|              |                          | Watts | 1.54                                      | 1.63     | 1.73     | 1.82     | 1.92     | /        | /        | /        | /        |
|              |                          | Amps  | 153                                       | 164      | 175      | 186      | 119      | /        | /        | /        | /        |
|              | Mid-Tap(3)               | SCFM  | 1219                                      | 1179     | 1140     | 1102     | 1066     | 1031     | 998      | 964      | 916      |
|              |                          | Watts | 2.03                                      | 2.14     | 2.24     | 2.34     | 2.46     | 2.56     | 2.66     | 2.76     | 2.88     |
|              |                          | Amps  | 211                                       | 223      | 235      | 248      | 261      | 274      | 286      | 297      | 312      |
|              | High-Tap(4)<br>(Factory) | SCFM  | 1350                                      | 1321     | 1283     | 1248     | 1214     | 1181     | 1147     | 1115     | 1084     |
|              |                          | Watts | 2.63                                      | 2.75     | 2.86     | 2.97     | 3.09     | 3.2      | 3.32     | 3.43     | 3.53     |
|              |                          | Amps  | 283                                       | 297      | 309      | 322      | 337      | 351      | 365      | 378      | 391      |
| 42           | Low-Tap(1)<br>(Factory)  | SCFM  | 1545                                      | 1507     | 1463     | 1418     | 1366     | 1307     | 1239     | 1144     | /        |
|              |                          | Watts | 487                                       | 479      | 469      | 458      | 447      | 433      | 418      | 400      | /        |
|              |                          | Amps  | 2.58                                      | 2.55     | 2.52     | 2.49     | 2.46     | 2.42     | 2.38     | 2.33     | /        |
|              | Mid-Tap(2)               | SCFM  | /   | /        | /        | /        | 1551     | 1488     | 1414     | 1318     | 1200     |
|              |                          | Watts | /   | /        | /        | /        | 728      | 712      | 693      | 672      | 644      |
|              |                          | Amps  | /   | /        | /        | /        | 4.1      | 4.05     | 3.99     | 3.92     | 3.84     |
|              | High-Tap(3)              | SCFM  | /   | /        | /        | /        | /        | /        | 1570     | 1499     | 1380     |
|              |                          | Watts | /   | /        | /        | /        | /        | /        | 812      | 787      | 759      |
|              |                          | Amps  | /   | /        | /        | /        | /        | /        | 4.57     | 4.49     | 4.4      |
| 48           | Low-Tap(1)<br>(Factory)  | SCFM  | 1545                                      | 1507     | 1463     | 1418     | 1366     | 1307     | 1239     | /        | /        |
|              |                          | Watts | 487                                       | 479      | 469      | 458      | 447      | 433      | 418      | /        | /        |
|              |                          | Amps  | 2.58                                      | 2.55     | 2.52     | 2.49     | 2.46     | 2.42     | 2.38     | /        | /        |
|              | Mid-Tap(2)               | SCFM  | 1740                                      | 1699     | 1654     | 1606     | 1551     | 1488     | 1414     | 1318     | 1200     |
|              |                          | Watts | 783                                       | 768      | 756      | 742      | 728      | 712      | 693      | 672      | 644      |
|              |                          | Amps  | 4.27                                      | 4.22     | 4.18     | 4.14     | 4.1      | 4.05     | 3.99     | 3.92     | 3.84     |
|              | High-Tap(3)              | SCFM  | /   | /        | /        | 1800     | 1740     | 1671     | 1595     | 1499     | 1380     |
|              |                          | Watts | /   | /        | /        | 874      | 854      | 833      | 812      | 787      | 759      |
|              |                          | Amps  | /   | /        | /        | 4.76     | 4.7      | 4.63     | 4.57     | 4.49     | 4.4      |
| 60           | Low-Tap(3)<br>(Factory)  | SCFM  | 1777                                      | 1728     | 1680     | 1635     | 1592     | 1549     | /        | /        | /        |
|              |                          | Watts | 2.8                                       | 2.9      | 3        | 3.1      | 3.2      | 3.3      | /        | /        | /        |
|              |                          | Amps  | 323                                       | 338      | 352      | 365      | 378      | 391      | /        | /        | /        |
|              | Mid-Tap(4)<br>(Factory)  | SCFM  | 1937                                      | 1889     | 1842     | 1792     | 1758     | 1720     | 1678     | 1636     | 1593     |
|              |                          | Watts | 3.5                                       | 3.6      | 3.7      | 3.8      | 3.9      | 4        | 4.1      | 4.2      | 4.3      |
|              |                          | Amps  | 412                                       | 428      | 444      | 457      | 471      | 486      | 499      | 513      | 527      |
|              | High-Tap(5)              | SCFM  | 2235                                      | 2191     | 2144     | 2091     | 2050     | 2010     | 1971     | 1936     | 1892     |
|              |                          | Watts | 4.5                                       | 5.1      | 5.3      | 5.4      | 5.5      | 5.6      | 5.7      | 5.8      | 5.8      |
|              |                          | Amps  | 623                                       | 642      | 660      | 673      | 689      | 704      | 719      | 734      | 744      |

Table 7-2 Duct Application(230V)

| Model Number | Motor Speed              |       | SCFM                                      |          |          |          |          |          |          |          |          |
|--------------|--------------------------|-------|---|----------|----------|----------|----------|----------|----------|----------|----------|
|              |                          |       | External Static Pressure-Inches W.C.[kPa] |          |          |          |          |          |          |          |          |
|              |                          |       | 0[0]                                      | 0.1[.02] | 0.2[.05] | 0.3[.07] | 0.4[.10] | 0.5[.12] | 0.6[.15] | 0.7[.17] | 0.8[.20] |
| 24           | Low-Tap(1)               | SCFM  | 885                                       | 841      | 795      | 743      | /        | /        | /        | /        | /        |
|              |                          | Watts | 227                                       | 224      | 221      | 216      | /        | /        | /        | /        | /        |
|              |                          | Amps  | 2.07                                      | 2.07     | 2.06     | 2.05     | /        | /        | /        | /        | /        |
|              | Mid-Tap(2)<br>(Factory)  | SCFM  | /   | /        | /        | 988      | 957      | 882      | 767      | /        | /        |
|              |                          | Watts | /   | /        | /        | 339      | 323      | 307      | 291      | /        | /        |
|              |                          | Amps  | /   | /        | /        | 2.31     | 2.28     | 2.26     | 2.24     | /        | /        |
|              | High-Tap(3)              | SCFM  | /   | /        | /        | /        | /        | 996      | 967      | 928      | 896      |
|              |                          | Watts | /   | /        | /        | /        | /        | 412      | 392      | 379      | 361      |
|              |                          | Amps  | /   | /        | /        | /        | /        | 2.65     | 2.57     | 2.52     | 2.46     |
| 30           | Low-Tap(1)               | SCFM  | 956                                       | 908      | 860      | 815      | 771      | /        | /        | /        | /        |
|              |                          | Watts | 1.2                                       | 1.27     | 1.35     | 1.44     | 1.52     | /        | /        | /        | /        |
|              |                          | Amps  | 114                                       | 122      | 131      | 141      | 151      | /        | /        | /        | /        |
|              | Mid-Tap(2)               | SCFM  | 1082                                      | 1039     | 996      | 958      | 917      | 881      | 831      | 780      | /        |
|              |                          | Watts | 1.54                                      | 1.63     | 1.73     | 1.82     | 1.92     | 2.01     | 2.12     | 2.21     | /        |
|              |                          | Amps  | 153                                       | 164      | 175      | 186      | 119      | 209      | 221      | 231      | /        |
|              | High-Tap(3)<br>(Factory) | SCFM  | /   | /        | /        | 1102     | 1066     | 1031     | 998      | 964      | 916      |
|              |                          | Watts | /   | /        | /        | 2.34     | 2.46     | 2.56     | 2.66     | 2.76     | 2.88     |
|              |                          | Amps  | /   | /        | /        | 248      | 261      | 274      | 286      | 297      | 312      |
| 36           | Low-Tap(2)               | SCFM  | 1082                                      | 1039     | 996      | 958      | 917      | /        | /        | /        | /        |
|              |                          | Watts | 1.54                                      | 1.63     | 1.73     | 1.82     | 1.92     | /        | /        | /        | /        |
|              |                          | Amps  | 153                                       | 164      | 175      | 186      | 119      | /        | /        | /        | /        |
|              | Mid-Tap(3)               | SCFM  | 1219                                      | 1179     | 1140     | 1102     | 1066     | 1031     | 998      | 964      | 916      |
|              |                          | Watts | 2.03                                      | 2.14     | 2.24     | 2.34     | 2.46     | 2.56     | 2.66     | 2.76     | 2.88     |
|              |                          | Amps  | 211                                       | 223      | 235      | 248      | 261      | 274      | 286      | 297      | 312      |
|              | High-Tap(4)<br>(Factory) | SCFM  | 1350                                      | 1321     | 1283     | 1248     | 1214     | 1181     | 1147     | 1115     | 1084     |
|              |                          | Watts | 2.63                                      | 2.75     | 2.86     | 2.97     | 3.09     | 3.2      | 3.32     | 3.43     | 3.53     |
|              |                          | Amps  | 283                                       | 297      | 309      | 322      | 337      | 351      | 365      | 378      | 391      |
| 42           | Low-Tap(1)<br>(Factory)  | SCFM  | /   | /        | /        | /        | 1554     | 1495     | 1429     | 1340     | 1230     |
|              |                          | Watts | /   | /        | /        | /        | 527      | 510      | 3046     | 465      | 432      |
|              |                          | Amps  | /   | /        | /        | /        | 2.29     | 2.22     | 13.24    | 2.02     | 1.88     |
|              | Mid-Tap(2)               | SCFM  | /   | /        | /        | /        | /        | /        | /        | 1503     | 1384     |
|              |                          | Watts | /   | /        | /        | /        | /        | /        | /        | 566      | 533      |
|              |                          | Amps  | /   | /        | /        | /        | /        | /        | /        | 2.46     | 2.32     |
|              | High-Tap(3)              | SCFM  | /   | /        | /        | /        | /        | /        | /        | /        | 1548     |
|              |                          | Watts | /   | /        | /        | /        | /        | /        | /        | /        | 662      |
|              |                          | Amps  | /   | /        | /        | /        | /        | /        | /        | /        | 2.88     |
| 48           | Low-Tap(1)<br>(Factory)  | SCFM  | 1735                                      | 1701     | 1654     | 1608     | 1554     | 1495     | 1429     | 1340     | /        |
|              |                          | Watts | 579                                       | 573      | 561      | 545      | 527      | 510      | 469      | 465      | /        |
|              |                          | Amps  | 2.52                                      | 2.49     | 2.44     | 2.37     | 2.29     | 2.22     | 2.15     | 2.02     | /        |
|              | Mid-Tap(2)               | SCFM  | /   | /        | /        | 1790     | 1730     | 1665     | 1591     | 1503     | 1384     |
|              |                          | Watts | /   | /        | /        | 658      | 642      | 614      | 592      | 566      | 533      |
|              |                          | Amps  | /   | /        | /        | 2.86     | 2.79     | 2.67     | 2.57     | 2.46     | 2.32     |
|              | High-Tap(3)              | SCFM  | /   | /        | /        | /        | /        | /        | 1761     | 1666     | 1548     |
|              |                          | Watts | /   | /        | /        | /        | /        | /        | 732      | 704      | 662      |
|              |                          | Amps  | /   | /        | /        | /        | /        | /        | 3.18     | 3.06     | 2.88     |
| 60           | Low-Tap(3)<br>(Factory)  | SCFM  | 1777                                      | 1728     | 1680     | 1635     | 1592     | 1549     | /        | /        | /        |
|              |                          | Watts | 2.8                                       | 2.9      | 3        | 3.1      | 3.2      | 3.3      | /        | /        | /        |
|              |                          | Amps  | 323                                       | 338      | 352      | 365      | 378      | 391      | /        | /        | /        |
|              | Mid-Tap(4)<br>(Factory)  | SCFM  | 1937                                      | 1889     | 1842     | 1792     | 1758     | 1720     | 1678     | 1636     | 1593     |
|              |                          | Watts | 3.5                                       | 3.6      | 3.7      | 3.8      | 3.9      | 4        | 4.1      | 4.2      | 4.3      |
|              |                          | Amps  | 412                                       | 428      | 444      | 457      | 471      | 486      | 499      | 513      | 527      |
|              | High-Tap(5)              | SCFM  | 2235                                      | 2191     | 2144     | 2091     | 2050     | 2010     | 1971     | 1936     | 1892     |
|              |                          | Watts | 4.5                                       | 5.1      | 5.3      | 5.4      | 5.5      | 5.6      | 5.7      | 5.8      | 5.8      |
|              |                          | Amps  | 623                                       | 642      | 660      | 673      | 689      | 704      | 719      | 734      | 744      |

\* The above airflow data for reference only.

\* In any situation , the airflow of the unit should be in the range of 80% to 130% of 400CFM/Ton.

- The air distribution system has the greatest effect on airflow. The duct system is totally controlled by the contractor. For this reason, the contractor should use only industry-recognized procedures.
- Heat pump systems require a specified airflow. Each ton of cooling requires between 300 and 450 cubic feet of air per minute (CFM), or 400 CFM nominally.
- Duct design and construction should be carefully done. System performance can be lowered dramatically due to poor duct design.

- Air supply diffusers must be selected and located carefully. They must be sized and positioned to deliver treated air along the perimeter of the space. If they are too small for their intended airflow, they become noisy. If they are not located properly, they cause drafts. Return air grilles must be properly sized to carry air back to the blower. If they are too small, they also cause noise.
- The installers should balance the air distribution system to ensure proper quiet airflow to all rooms in the home. This ensures a comfortable living space.
- An air velocity meter or airflow hood can give a reading of system CFM.
- During installation, installer should select the air speed according to the actual setting static pressure. Please refer to the Table 7-1 AIRFLOW PERFORMANCE DATA

Table 7-3 Electric Heat Pressure Drop Tables(IN.W.C)

**Small Cabinet:24K,30K,36K**

| STATIC | STANDARD CFM (SCFM) |      |      |      |      |      |
|--------|---------------------|------|------|------|------|------|
|        | 900                 | 1000 | 1100 | 1200 | 1300 | 1400 |
| 5kW    | 0.05                | 0.05 | 0.05 | 0.05 | 0.05 | 0.1  |
| 7.5kW  | 0.05                | 0.05 | 0.05 | 0.05 | 0.05 | 0.1  |
| 10kW   | 0.05                | 0.05 | 0.05 | 0.05 | 0.05 | 0.1  |
| 15kW   | /                   | /    | 0.1  | 0.1  | 0.1  | 0.1  |

**Large Cabinet:42K,48K,60K**

| STATIC | STANDARD CFM (SCFM) |      |      |      |      |      |      |      |
|--------|---------------------|------|------|------|------|------|------|------|
|        | 1500                | 1600 | 1700 | 1800 | 1900 | 2000 | 2100 | 2200 |
| 5kW    | 0.1                 | 0.1  | 0.1  | 0.1  | 0.15 | 0.15 | 0.15 | 0.15 |
| 7.5kW  | 0.1                 | 0.1  | 0.1  | 0.1  | 0.15 | 0.15 | 0.15 | 0.15 |
| 10kW   | 0.1                 | 0.1  | 0.15 | 0.15 | 0.15 | 0.15 | 0.15 | 0.15 |
| 15kW   | /                   | /    | 0.2  | 0.2  | 0.2  | 0.2  | 0.2  | 0.2  |
| 20kW   | /                   | /    | 0.2  | 0.2  | 0.2  | 0.2  | 0.2  | 0.25 |

Table 7-4 Refrigerant charge for H/P system

| 24<br>Cooling Mode<br>Mode<br>De Refroidissement |   | Cooling Charge Chart/Tableau De Charge de Refroidissement                  |     |     |     |     |     |     |     |     |     |     |     |     |     |
|--|---|--|-----|-----|-----|-----|-----|-----|-----|-----|-----|-----|-----|-----|-----|
|  |   | Outdoor Ambient Temperature(oF)/Temperature Amdiante Exterieur(e en oF)    |     |     |     |     |     |     |     |     |     |     |     |     |     |
|  |   | 55   | 60  | 65  | 70  | 75  | 80  | 85  | 90  | 95  | 100 | 105 | 110 | 115 |     |
|  |   | High Pressure Service Port (psig)/Vanne Détecté de Pression Haute(en psig) |     |     |     |     |     |     |     |     |     |     |     |     |     |
| Low Pressure Service Port(psig)                  | Vanne Détectée de Pression Basse(en psig) | 165  |     |     | 303 | 316 | 328 | 350 | 370 | 400 | 426 | 446 | 465 | 487 | 508 |
|  |   | 161  |     |     | 300 | 313 | 325 | 346 | 366 | 394 | 421 | 440 | 459 | 481 | 503 |
|  |   | 157  |     |     | 297 | 310 | 322 | 342 | 362 | 389 | 415 | 434 | 453 | 476 | 499 |
|  |   | 153  |     | 282 | 294 | 307 | 319 | 339 | 358 | 384 | 410 | 428 | 446 | 471 | 496 |
|  |   | 149  |     | 279 | 291 | 304 | 316 | 335 | 353 | 374 | 399 | 419 | 443 | 468 | 493 |
|  |   | 145  |     | 275 | 287 | 300 | 312 | 331 | 349 | 370 | 393 | 416 | 440 | 465 | 490 |
|  |   | 141  | 256 | 272 | 284 | 297 | 309 | 328 | 346 | 368 | 389 | 413 | 437 | 462 | 486 |
|  |   | 137  | 251 | 268 | 280 | 293 | 305 | 324 | 343 | 365 | 386 | 410 | 434 | 459 | 483 |
|  |   | 133  | 246 | 264 | 276 | 289 | 301 | 321 | 340 | 361 | 382 | 406 | 430 | 455 | 479 |
|  |   | 129  | 241 | 260 | 272 | 285 | 297 | 317 | 336 | 357 | 378 | 403 | 427 | 451 | 475 |
|  |   | 125  | 236 | 256 | 268 | 281 | 293 | 313 | 332 | 353 | 374 | 399 | 423 | 447 | 471 |
|  |   | 121  | 231 | 252 | 264 | 277 | 289 | 309 | 328 | 349 | 370 | 395 | 420 | 444 | 467 |
|  |   | 117  | 226 | 248 | 260 | 273 | 285 | 305 | 324 | 345 | 366 | 392 | 417 | 440 | 463 |
|  |   | 113  | 221 | 244 | 256 | 269 | 281 | 301 | 320 | 341 | 362 | 388 | 414 | 437 | 459 |
|  |   | 109  | 216 | 240 | 252 | 265 | 277 | 297 | 316 | 337 | 358 | 385 | 411 | 433 | 455 |
| 105  | 211                                       | 236  | 248 | 261 | 273 | 293 | 312 | 333 | 354 | 381 | 408 | 429 | 450 |     |     |



Table 7-5 Refrigerant charge for H/P system

| 24<br>Heating Mode<br>Mode<br>De Chauffage |   |     | Heating Charge Chart/Tableau De Charge de Chauffage                            |     |     |     |     |     |     |     |     |     |     |     |  |
|--|---|-----|--|-----|-----|-----|-----|-----|-----|-----|-----|-----|-----|-----|--|
|  |   |     | Indoor Dry Bulb Temperature(oF)/Temperature Interieur au Themometre sec(en oF) |     |     |     |     |     |     |     |     |     |     |     |  |
|  |   |     | 60   | 62  | 64  | 66  | 68  | 70  | 72  | 74  | 76  | 78  | 80  | 82  |  |
|  |   |     | High Pressure Service Port(psig)/Vanne Détecté de Pression Haute(en psig)      |     |     |     |     |     |     |     |     |     |     |     |  |
| Low Pressure Service Port(psig)            | Vanne Détectée de Pression Basse(en psig) | 135 | 361  | 369 | 377 | 385 | 393 | 401 | 409 | 417 | 425 | 433 | 441 | 448 |  |
|  |   | 128 | 346  | 354 | 361 | 369 | 377 | 385 | 393 | 400 | 408 | 416 | 424 | 431 |  |
|  |   | 121 | 331  | 338 | 346 | 353 | 361 | 369 | 376 | 384 | 391 | 399 | 407 | 414 |  |
|  |   | 114 | 315  | 323 | 330 | 338 | 345 | 352 | 360 | 367 | 375 | 382 | 389 | 396 |  |
|  |   | 107 | 300  | 307 | 315 | 322 | 329 | 336 | 343 | 351 | 358 | 365 | 372 | 379 |  |
|  |   | 100 | 285  | 292 | 299 | 306 | 313 | 320 | 327 | 334 | 341 | 348 | 355 | 362 |  |
|  |   | 93  | 276  | 283 | 289 | 296 | 303 | 310 | 317 | 324 | 331 | 338 | 345 | 352 |  |
|  |   | 86  | 267  | 273 | 280 | 286 | 293 | 300 | 307 | 314 | 321 | 328 | 335 | 342 |  |
|  |   | 79  | 257  | 264 | 270 | 277 | 283 | 289 | 296 | 303 | 310 | 317 | 324 | 331 |  |
|  |   | 72  | 248  | 254 | 261 | 267 | 273 | 279 | 286 | 293 | 300 | 307 | 314 | 321 |  |
|  |   | 65  | 239  | 245 | 251 | 257 | 263 | 269 | 276 | 283 | 290 | 297 | 304 | 311 |  |
|  |   | 58  |  |     |     |     | 256 | 262 | 269 | 276 | 283 | 290 | 297 | 304 |  |
|  |   | 51  |  |     |     |     |     | 255 | 262 | 269 | 276 | 283 | 290 | 297 |  |
|  |   | 44  |  |     |     |     |     |     | 255 | 262 | 269 | 276 | 283 | 290 |  |
|  |   | 37  |  |     |     |     |     |     |     | 255 | 262 | 269 | 276 | 283 |  |
|  |   | 30  |  |     |     |     |     |     |     |     |     |     |     |     |  |

Table 7-6 Refrigerant charge for H/P system

| 30<br>Cooling Mode<br>Mode<br>De Refroidissement |   |     | Cooling Charge Chart/Tableau De Charge de Refroidissement                  |     |     |     |     |     |     |     |     |     |     |     |     |
|--|---|-----|--|-----|-----|-----|-----|-----|-----|-----|-----|-----|-----|-----|-----|
|  |   |     | Outdoor Ambient Temperature(oF)/Temperature Amdiante Exterieur(en oF)      |     |     |     |     |     |     |     |     |     |     |     |     |
|  |   |     | 55   | 60  | 65  | 70  | 75  | 80  | 85  | 90  | 95  | 100 | 105 | 110 | 115 |
|  |   |     | High Pressure Service Port (psig)/Vanne Détecté de Pression Haute(en psig) |     |     |     |     |     |     |     |     |     |     |     |     |
| Low Pressure Service Port(psig)                  | Vanne Détectée de Pression Basse(en psig) | 165 |  |     | 281 | 303 | 324 | 346 | 365 | 383 | 402 | 425 | 449 | 472 | 495 |
|  |   | 161 |  |     | 279 | 301 | 322 | 344 | 363 | 381 | 400 | 423 | 447 | 470 | 493 |
|  |   | 157 |  |     | 277 | 299 | 320 | 342 | 361 | 379 | 398 | 421 | 445 | 468 | 491 |
|  |   | 153 |  | 253 | 275 | 297 | 318 | 340 | 359 | 377 | 396 | 419 | 443 | 466 | 489 |
|  |   | 149 |  | 251 | 273 | 295 | 316 | 338 | 357 | 375 | 394 | 417 | 441 | 464 | 487 |
|  |   | 145 |  | 249 | 271 | 293 | 314 | 336 | 355 | 373 | 392 | 415 | 439 | 462 | 485 |
|  |   | 141 | 226  | 247 | 269 | 291 | 312 | 334 | 353 | 371 | 390 | 413 | 437 | 460 | 483 |
|  |   | 137 | 224  | 245 | 267 | 289 | 310 | 332 | 351 | 369 | 388 | 411 | 435 | 458 | 481 |
|  |   | 133 | 222  | 243 | 265 | 287 | 308 | 330 | 349 | 367 | 386 | 409 | 433 | 456 | 479 |
|  |   | 129 | 220  | 241 | 263 | 285 | 306 | 328 | 347 | 365 | 384 | 407 | 431 | 454 | 477 |
|  |   | 125 | 218  | 239 | 261 | 283 | 304 | 326 | 345 | 363 | 382 | 405 | 429 | 452 | 475 |
|  |   | 121 | 216  | 237 | 259 | 281 | 302 | 324 | 343 | 361 | 380 | 403 | 427 | 450 | 473 |
|  |   | 117 | 214  | 235 | 257 | 279 | 300 | 322 | 341 | 359 | 378 | 401 | 425 | 448 | 471 |
|  |   | 113 | 212  | 233 | 255 | 277 | 298 | 320 | 339 | 357 | 376 | 399 | 423 | 446 | 469 |
|  |   | 109 | 210  | 231 | 253 | 275 | 296 | 318 | 337 | 355 | 374 | 397 | 421 | 444 | 467 |
|  |   | 105 | 208  | 229 | 251 | 273 | 294 | 316 | 335 | 353 | 372 | 395 | 419 | 442 | 465 |

Table 7-7 Refrigerant charge for H/P system

| 30<br>Heating Mode<br>Mode<br>De Chauffage |   | Heating Charge Chart/Tableau De Charge de Chauffage                            |     |     |     |     |     |     |     |     |     |     |     |     |  |
|--|---|--|-----|-----|-----|-----|-----|-----|-----|-----|-----|-----|-----|-----|--|
|  |   | Indoor Dry Bulb Temperature(oF)/Temperature Interieur au Themometre sec(en oF) |     |     |     |     |     |     |     |     |     |     |     |     |  |
|  |   | 60   | 62  | 64  | 66  | 68  | 70  | 72  | 74  | 76  | 78  | 80  | 82  |     |  |
|  |   | High Pressure Service Port(psig)/Vanne Détecté de Pression Haute(en psig)      |     |     |     |     |     |     |     |     |     |     |     |     |  |
| Low Pressure Service Port(psig)            | Vanne Détectée de Pression Basse(en psig) | 135  | 361 | 369 | 377 | 385 | 393 | 401 | 409 | 417 | 425 | 433 | 441 | 448 |  |
|  |   | 128  | 346 | 354 | 361 | 369 | 377 | 385 | 393 | 400 | 408 | 416 | 424 | 431 |  |
|  |   | 121  | 331 | 338 | 346 | 353 | 361 | 369 | 376 | 384 | 391 | 399 | 407 | 414 |  |
|  |   | 114  | 315 | 323 | 330 | 338 | 345 | 352 | 360 | 367 | 375 | 382 | 389 | 396 |  |
|  |   | 107  | 300 | 307 | 315 | 322 | 329 | 336 | 343 | 351 | 358 | 365 | 372 | 379 |  |
|  |   | 100  | 285 | 292 | 299 | 306 | 313 | 320 | 327 | 334 | 341 | 348 | 355 | 362 |  |
|  |   | 93   | 275 | 282 | 289 | 296 | 302 | 309 | 316 | 323 | 330 | 337 | 344 | 351 |  |
|  |   | 86   | 265 | 272 | 279 | 285 | 292 | 298 | 305 | 312 | 319 | 326 | 333 | 340 |  |
|  |   | 79   | 256 | 262 | 268 | 275 | 281 | 288 | 295 | 302 | 309 | 316 | 323 | 330 |  |
|  |   | 72   | 246 | 252 | 258 | 264 | 271 | 277 | 284 | 291 | 298 | 305 | 312 | 319 |  |
|  |   | 65   | 236 | 242 | 248 | 254 | 260 | 266 | 273 | 280 | 287 | 294 | 301 | 308 |  |
|  |   | 58   |     |     |     |     | 253 | 259 | 266 | 273 | 280 | 287 | 294 | 301 |  |
|  |   | 51   |     |     |     |     |     | 252 | 259 | 266 | 273 | 280 | 287 | 294 |  |
|  |   | 44   |     |     |     |     |     |     | 252 | 259 | 266 | 273 | 280 | 287 |  |
|  |   | 37   |     |     |     |     |     |     |     | 252 | 259 | 266 | 273 | 280 |  |
| 30   |   |  |     |     |     |     |     |     |     |     |     |     |     |     |  |

Table 7-8 Refrigerant charge for H/P system

| 36<br>Cooling Mode<br>Mode<br>De Refroidissement |   | Cooling Charge Chart/Tableau De Charge de Refroidissement                  |     |     |     |     |     |     |     |     |     |     |     |     |     |
|--|---|--|-----|-----|-----|-----|-----|-----|-----|-----|-----|-----|-----|-----|-----|
|  |   | Outdoor Ambient Temperature(oF)/Temperature Amiante Exterieur(en oF)       |     |     |     |     |     |     |     |     |     |     |     |     |     |
|  |   | 55   | 60  | 65  | 70  | 75  | 80  | 85  | 90  | 95  | 100 | 105 | 110 | 115 |     |
|  |   | High Pressure Service Port (psig)/Vanne Détecté de Pression Haute(en psig) |     |     |     |     |     |     |     |     |     |     |     |     |     |
| Low Pressure Service Port(psig)                  | Vanne Détectée de Pression Basse(en psig) | 165  |     |     | 313 | 328 | 343 | 357 | 370 | 391 | 423 | 448 | 472 | 495 | 521 |
|  |   | 161  |     |     | 309 | 324 | 339 | 353 | 366 | 387 | 419 | 444 | 468 | 491 | 516 |
|  |   | 157  |     |     | 305 | 320 | 335 | 349 | 362 | 383 | 415 | 439 | 463 | 486 | 512 |
|  |   | 153  |     | 286 | 301 | 316 | 331 | 345 | 358 | 379 | 411 | 435 | 459 | 482 | 508 |
|  |   | 149  |     | 282 | 297 | 312 | 327 | 341 | 354 | 375 | 407 | 431 | 455 | 478 | 503 |
|  |   | 145  |     | 278 | 293 | 308 | 323 | 337 | 350 | 372 | 404 | 428 | 451 | 474 | 500 |
|  |   | 141  | 253 | 274 | 289 | 304 | 319 | 333 | 346 | 368 | 401 | 424 | 447 | 470 | 495 |
|  |   | 137  | 246 | 268 | 283 | 298 | 313 | 328 | 342 | 363 | 397 | 421 | 444 | 471 | 501 |
|  |   | 133  | 241 | 264 | 279 | 294 | 309 | 324 | 339 | 360 | 394 | 418 | 441 | 463 | 487 |
|  |   | 129  | 236 | 260 | 275 | 290 | 305 | 321 | 337 | 358 | 391 | 415 | 438 | 461 | 486 |
|  |   | 125  | 231 | 256 | 271 | 286 | 301 | 317 | 333 | 355 | 389 | 412 | 435 | 457 | 482 |
|  |   | 121  | 226 | 252 | 267 | 282 | 297 | 313 | 329 | 351 | 386 | 409 | 432 | 454 | 478 |
|  |   | 117  | 221 | 248 | 263 | 278 | 293 | 309 | 325 | 348 | 383 | 406 | 429 | 450 | 474 |
|  |   | 113  | 216 | 244 | 259 | 274 | 289 | 305 | 321 | 344 | 380 | 403 | 426 | 447 | 470 |
|  |   | 109  | 211 | 240 | 255 | 270 | 285 | 301 | 317 | 341 | 377 | 400 | 423 | 443 | 466 |
| 105  | 206                                       | 236  | 251 | 266 | 281 | 297 | 313 | 337 | 374 | 397 | 420 | 440 | 462 |     |     |

Table 7-9 Refrigerant charge for H/P system

| 36<br>Heating Mode<br>Mode<br>De Chauffage |   | Heating Charge Chart/Tableau De Charge de Chauffage                            |     |     |     |     |     |     |     |     |     |     |     |     |  |
|--|---|--|-----|-----|-----|-----|-----|-----|-----|-----|-----|-----|-----|-----|--|
|  |   | Indoor Dry Bulb Temperature(oF)/Temperature Interieur au Themometre sec(en oF) |     |     |     |     |     |     |     |     |     |     |     |     |  |
|  |   | 60   | 62  | 64  | 66  | 68  | 70  | 72  | 74  | 76  | 78  | 80  | 82  |     |  |
|  |   | High Pressure Service Port(psig)/Vanne Détecté de Pression Haute(en psig)      |     |     |     |     |     |     |     |     |     |     |     |     |  |
| Low Pressure Service Port(psig)            | Vanne Détectée de Pression Basse(en psig) | 135  | 344 | 352 | 360 | 368 | 376 | 384 | 392 | 400 | 408 | 416 | 424 | 431 |  |
|  |   | 128  | 335 | 343 | 350 | 358 | 366 | 374 | 382 | 389 | 397 | 405 | 413 | 420 |  |
|  |   | 121  | 326 | 333 | 341 | 348 | 356 | 364 | 371 | 379 | 386 | 394 | 402 | 409 |  |
|  |   | 114  | 316 | 324 | 331 | 339 | 346 | 353 | 361 | 368 | 376 | 383 | 390 | 397 |  |
|  |   | 107  | 307 | 314 | 322 | 329 | 336 | 343 | 350 | 358 | 365 | 372 | 379 | 386 |  |
|  |   | 100  | 298 | 305 | 312 | 319 | 326 | 333 | 340 | 347 | 354 | 361 | 368 | 375 |  |
|  |   | 93   | 287 | 293 | 300 | 307 | 314 | 321 | 328 | 335 | 342 | 349 | 356 | 363 |  |
|  |   | 86   | 275 | 282 | 288 | 295 | 302 | 308 | 315 | 322 | 329 | 336 | 343 | 350 |  |
|  |   | 79   | 264 | 270 | 277 | 283 | 289 | 296 | 303 | 310 | 317 | 324 | 331 | 338 |  |
|  |   | 72   | 252 | 259 | 265 | 271 | 277 | 283 | 290 | 297 | 304 | 311 | 318 | 325 |  |
|  |   | 65   | 241 | 247 | 253 | 259 | 265 | 271 | 278 | 285 | 292 | 299 | 306 | 313 |  |
|  |   | 58   |     |     |     |     | 258 | 264 | 271 | 278 | 285 | 292 | 299 | 306 |  |
|  |   | 51   |     |     |     |     |     | 257 | 264 | 271 | 278 | 285 | 292 | 299 |  |
|  |   | 44   |     |     |     |     |     |     | 257 | 264 | 271 | 278 | 285 | 292 |  |
|  |   | 37   |     |     |     |     |     |     |     | 257 | 264 | 271 | 278 | 285 |  |
|  |   | 30   |     |     |     |     |     |     |     |     |     |     |     |     |  |

Table 7-10 Refrigerant charge for H/P system

| 42<br>Cooling Mode<br>Mode<br>De Refroidissement |   | Cooling Charge Chart/Tableau De Charge de Refroidissement                  |     |     |     |     |     |     |     |     |     |     |     |     |     |
|--|---|--|-----|-----|-----|-----|-----|-----|-----|-----|-----|-----|-----|-----|-----|
|  |   | Outdoor Ambient Temperature(oF)/Temperature Amdiante Exterieur(en oF)      |     |     |     |     |     |     |     |     |     |     |     |     |     |
|  |   | 55   | 60  | 65  | 70  | 75  | 80  | 85  | 90  | 95  | 100 | 105 | 110 | 115 |     |
|  |   | High Pressure Service Port (psig)/Vanne Détecté de Pression Haute(en psig) |     |     |     |     |     |     |     |     |     |     |     |     |     |
| Low Pressure Service Port(psig)                  | Vanne Détectée de Pression Basse(en psig) | 165  |     |     | 267 | 288 | 310 | 331 | 347 | 364 | 380 | 405 | 430 | 454 | 479 |
|  |   | 161  |     |     | 265 | 286 | 308 | 329 | 345 | 362 | 378 | 403 | 428 | 452 | 477 |
|  |   | 157  |     |     | 263 | 284 | 306 | 327 | 343 | 360 | 376 | 401 | 426 | 450 | 475 |
|  |   | 153  |     | 240 | 261 | 282 | 304 | 325 | 341 | 358 | 374 | 399 | 424 | 448 | 473 |
|  |   | 149  |     | 238 | 259 | 280 | 302 | 323 | 339 | 356 | 372 | 397 | 422 | 446 | 471 |
|  |   | 145  |     | 236 | 257 | 278 | 300 | 321 | 337 | 354 | 370 | 395 | 420 | 444 | 469 |
|  |   | 141  | 212 | 234 | 255 | 276 | 298 | 319 | 335 | 352 | 368 | 393 | 418 | 442 | 467 |
|  |   | 137  | 210 | 232 | 253 | 274 | 296 | 317 | 333 | 350 | 366 | 391 | 416 | 440 | 465 |
|  |   | 133  | 208 | 230 | 251 | 272 | 294 | 315 | 331 | 348 | 364 | 389 | 414 | 438 | 463 |
|  |   | 129  | 206 | 228 | 249 | 270 | 292 | 313 | 329 | 346 | 362 | 387 | 412 | 436 | 461 |
|  |   | 125  | 204 | 226 | 247 | 268 | 290 | 311 | 327 | 344 | 360 | 385 | 410 | 434 | 459 |
|  |   | 121  | 202 | 224 | 245 | 266 | 288 | 309 | 325 | 342 | 358 | 383 | 408 | 432 | 457 |
|  |   | 117  | 200 | 222 | 243 | 264 | 286 | 307 | 323 | 340 | 356 | 381 | 406 | 430 | 455 |
|  |   | 113  | 198 | 220 | 241 | 262 | 284 | 305 | 321 | 338 | 354 | 379 | 404 | 428 | 453 |
|  |   | 109  | 196 | 218 | 239 | 260 | 282 | 303 | 319 | 336 | 352 | 377 | 402 | 426 | 451 |
|  |   | 105  | 194 | 216 | 237 | 258 | 280 | 301 | 317 | 334 | 350 | 375 | 400 | 424 | 449 |

Table 7-11 Refrigerant charge for H/P system

| 42<br>Heating Mode<br>Mode<br>De Chauffage |   | Heating Charge Chart/Tableau De Charge de Chauffage                            |     |     |     |     |     |     |     |     |     |     |     |     |  |
|--|---|--|-----|-----|-----|-----|-----|-----|-----|-----|-----|-----|-----|-----|--|
|  |   | Indoor Dry Bulb Temperature(oF)/Temperature Interieur au Themometre sec(en oF) |     |     |     |     |     |     |     |     |     |     |     |     |  |
|  |   | 60   | 62  | 64  | 66  | 68  | 70  | 72  | 74  | 76  | 78  | 80  | 82  |     |  |
|  |   | High Pressure Service Port(psig)/Vanne Détecté de Pression Haute(en psig)      |     |     |     |     |     |     |     |     |     |     |     |     |  |
| Low Pressure Service Port(psig)            | Vanne Détectée de Pression Basse(en psig) | 135  | 388 | 396 | 404 | 412 | 420 | 428 | 436 | 444 | 452 | 460 | 468 | 475 |  |
|  |   | 128  | 364 | 372 | 380 | 387 | 395 | 403 | 411 | 419 | 426 | 434 | 442 | 449 |  |
|  |   | 121  | 340 | 348 | 355 | 363 | 370 | 378 | 386 | 393 | 401 | 408 | 416 | 423 |  |
|  |   | 114  | 316 | 323 | 331 | 338 | 346 | 353 | 360 | 368 | 375 | 383 | 390 | 397 |  |
|  |   | 107  | 292 | 299 | 306 | 314 | 321 | 328 | 335 | 342 | 350 | 357 | 364 | 371 |  |
|  |   | 100  | 268 | 275 | 282 | 289 | 296 | 303 | 310 | 317 | 324 | 331 | 338 | 345 |  |
|  |   | 93   | 261 | 268 | 275 | 281 | 288 | 295 | 302 | 309 | 316 | 323 | 330 | 337 |  |
|  |   | 86   | 254 | 261 | 267 | 274 | 280 | 287 | 294 | 301 | 308 | 315 | 322 | 329 |  |
|  |   | 79   | 247 | 253 | 260 | 266 | 273 | 279 | 286 | 293 | 300 | 307 | 314 | 321 |  |
|  |   | 72   | 240 | 246 | 252 | 259 | 265 | 271 | 278 | 285 | 292 | 299 | 306 | 313 |  |
|  |   | 65   | 233 | 239 | 245 | 251 | 257 | 263 | 270 | 277 | 284 | 291 | 298 | 305 |  |
|  |   | 58   |     |     |     |     | 250 | 256 | 263 | 270 | 277 | 284 | 291 | 298 |  |
|  |   | 51   |     |     |     |     |     | 249 | 256 | 263 | 270 | 277 | 284 | 291 |  |
|  |   | 44   |     |     |     |     |     |     | 249 | 256 | 263 | 270 | 277 | 284 |  |
|  |   | 37   |     |     |     |     |     |     |     | 249 | 256 | 263 | 270 | 277 |  |
|  |   | 30   |     |     |     |     |     |     |     |     |     |     |     |     |  |

Table 7-12 Refrigerant charge for H/P system

| 48<br>Cooling Mode<br>Mode<br>De Refroidissement |   | Cooling Charge Chart/Tableau De Charge de Refroidissement                  |     |     |     |     |     |     |     |     |     |     |     |     |     |
|--|---|--|-----|-----|-----|-----|-----|-----|-----|-----|-----|-----|-----|-----|-----|
|  |   | Outdoor Ambient Temperature(oF)/Temperature Amiante Exterieur(en oF)       |     |     |     |     |     |     |     |     |     |     |     |     |     |
|  |   | 55   | 60  | 65  | 70  | 75  | 80  | 85  | 90  | 95  | 100 | 105 | 110 | 115 |     |
|  |   | High Pressure Service Port (psig)/Vanne Détecté de Pression Haute(en psig) |     |     |     |     |     |     |     |     |     |     |     |     |     |
| Low Pressure Service Port(psig)                  | Vanne Détectée de Pression Basse(en psig) | 165  |     |     | 277 | 298 | 320 | 341 | 359 | 378 | 396 | 421 | 445 | 470 | 494 |
|  |   | 161  |     |     | 275 | 296 | 318 | 339 | 357 | 376 | 394 | 419 | 443 | 468 | 492 |
|  |   | 157  |     |     | 273 | 294 | 316 | 337 | 355 | 374 | 392 | 417 | 441 | 466 | 490 |
|  |   | 153  |     | 250 | 271 | 292 | 314 | 335 | 353 | 372 | 390 | 415 | 439 | 464 | 488 |
|  |   | 149  |     | 248 | 269 | 290 | 312 | 333 | 351 | 370 | 388 | 413 | 437 | 462 | 486 |
|  |   | 145  |     | 246 | 267 | 288 | 310 | 331 | 349 | 368 | 386 | 411 | 435 | 460 | 484 |
|  |   | 141  | 222 | 244 | 265 | 286 | 308 | 329 | 347 | 366 | 384 | 409 | 433 | 458 | 482 |
|  |   | 137  | 220 | 242 | 263 | 284 | 306 | 327 | 345 | 364 | 382 | 407 | 431 | 456 | 480 |
|  |   | 133  | 218 | 240 | 261 | 282 | 304 | 325 | 343 | 362 | 380 | 405 | 429 | 454 | 478 |
|  |   | 129  | 216 | 238 | 259 | 280 | 302 | 323 | 341 | 360 | 378 | 403 | 427 | 452 | 476 |
|  |   | 125  | 214 | 236 | 257 | 278 | 300 | 321 | 339 | 358 | 376 | 401 | 425 | 450 | 474 |
|  |   | 121  | 212 | 234 | 255 | 276 | 298 | 319 | 337 | 356 | 374 | 399 | 423 | 448 | 472 |
|  |   | 117  | 210 | 232 | 253 | 274 | 296 | 317 | 335 | 354 | 372 | 397 | 421 | 446 | 470 |
|  |   | 113  | 208 | 230 | 251 | 272 | 294 | 315 | 333 | 352 | 370 | 395 | 419 | 444 | 468 |
|  |   | 109  | 206 | 228 | 249 | 270 | 292 | 313 | 331 | 350 | 368 | 393 | 417 | 442 | 466 |
|  |   | 105  | 204 | 226 | 247 | 268 | 290 | 311 | 329 | 348 | 366 | 391 | 415 | 440 | 464 |

Table 7-13 Refrigerant charge for H/P system

| 48<br>Heating Mode<br>Mode<br>De Chauffage |   | Heating Charge Chart/Tableau De Charge de Chauffage                            |     |     |     |     |     |     |     |     |     |     |     |     |  |
|--|---|--|-----|-----|-----|-----|-----|-----|-----|-----|-----|-----|-----|-----|--|
|  |   | Indoor Dry Bulb Temperature(oF)/Temperature Interieur au Themometre sec(en oF) |     |     |     |     |     |     |     |     |     |     |     |     |  |
|  |   | 60   | 62  | 64  | 66  | 68  | 70  | 72  | 74  | 76  | 78  | 80  | 82  |     |  |
|  |   | High Pressure Service Port(psig)/Vanne Détecté de Pression Haute(en psig)      |     |     |     |     |     |     |     |     |     |     |     |     |  |
| Low Pressure Service Port(psig)            | Vanne Détectée de Pression Basse(en psig) | 135  | 418 | 426 | 434 | 442 | 450 | 458 | 466 | 474 | 482 | 490 | 498 | 505 |  |
|  |   | 128  | 392 | 400 | 408 | 415 | 423 | 431 | 439 | 447 | 454 | 462 | 470 | 477 |  |
|  |   | 121  | 366 | 374 | 381 | 389 | 396 | 404 | 412 | 419 | 427 | 434 | 442 | 449 |  |
|  |   | 114  | 340 | 347 | 355 | 362 | 370 | 377 | 384 | 392 | 399 | 407 | 414 | 421 |  |
|  |   | 107  | 314 | 321 | 328 | 336 | 343 | 350 | 357 | 364 | 372 | 379 | 386 | 393 |  |
|  |   | 100  | 288 | 295 | 302 | 309 | 316 | 323 | 330 | 337 | 344 | 351 | 358 | 365 |  |
|  |   | 93   | 279 | 285 | 292 | 299 | 306 | 313 | 320 | 327 | 334 | 341 | 348 | 355 |  |
|  |   | 86   | 269 | 276 | 282 | 289 | 296 | 302 | 309 | 316 | 323 | 330 | 337 | 344 |  |
|  |   | 79   | 260 | 266 | 273 | 279 | 285 | 292 | 299 | 306 | 313 | 320 | 327 | 334 |  |
|  |   | 72   | 250 | 257 | 263 | 269 | 275 | 281 | 288 | 295 | 302 | 309 | 316 | 323 |  |
|  |   | 65   | 241 | 247 | 253 | 259 | 265 | 271 | 278 | 285 | 292 | 299 | 306 | 313 |  |
|  |   | 58   |     |     |     |     | 258 | 264 | 271 | 278 | 285 | 292 | 299 | 306 |  |
|  |   | 51   |     |     |     |     |     | 257 | 264 | 271 | 278 | 285 | 292 | 299 |  |
|  |   | 44   |     |     |     |     |     |     | 257 | 264 | 271 | 278 | 285 | 292 |  |
|  |   | 37   |     |     |     |     |     |     |     | 257 | 264 | 271 | 278 | 285 |  |
| 30   |   |  |     |     |     |     |     |     |     |     |     |     |     |     |  |

Table 7-14 Refrigerant charge for H/P system

| 60<br>Cooling Mode<br>Mode<br>De Refroidissement |   | Cooling Charge Chart/Tableau De Charge de Refroidissement                  |     |     |     |     |     |     |     |     |     |     |     |     |     |
|--|---|--|-----|-----|-----|-----|-----|-----|-----|-----|-----|-----|-----|-----|-----|
|  |   | Outdoor Ambient Temperature(oF)/Temperature Amdiante Exterieur(en oF)      |     |     |     |     |     |     |     |     |     |     |     |     |     |
|  |   | 55   | 60  | 65  | 70  | 75  | 80  | 85  | 90  | 95  | 100 | 105 | 110 | 115 |     |
|  |   | High Pressure Service Port (psig)/Vanne Détecté de Pression Haute(en psig) |     |     |     |     |     |     |     |     |     |     |     |     |     |
| Low Pressure Service Port(psig)                  | Vanne Détectée de Pression Basse(en psig) | 165  |     |     | 297 | 318 | 339 | 360 | 379 | 399 | 418 | 442 | 466 | 490 | 514 |
|  |   | 161  |     |     | 295 | 316 | 337 | 358 | 377 | 397 | 416 | 440 | 464 | 488 | 512 |
|  |   | 157  |     |     | 293 | 314 | 335 | 356 | 375 | 395 | 414 | 438 | 462 | 486 | 510 |
|  |   | 153  |     | 270 | 291 | 312 | 333 | 354 | 373 | 393 | 412 | 436 | 460 | 484 | 508 |
|  |   | 149  |     | 268 | 289 | 310 | 331 | 352 | 371 | 391 | 410 | 434 | 458 | 482 | 506 |
|  |   | 145  |     | 266 | 287 | 308 | 329 | 350 | 369 | 389 | 408 | 432 | 456 | 480 | 504 |
|  |   | 141  | 243 | 264 | 285 | 306 | 327 | 348 | 367 | 387 | 406 | 430 | 454 | 478 | 502 |
|  |   | 137  | 241 | 262 | 283 | 304 | 325 | 346 | 365 | 385 | 404 | 428 | 452 | 476 | 500 |
|  |   | 133  | 239 | 260 | 281 | 302 | 323 | 344 | 363 | 383 | 402 | 426 | 450 | 474 | 498 |
|  |   | 129  | 237 | 258 | 279 | 300 | 321 | 342 | 361 | 381 | 400 | 424 | 448 | 472 | 496 |
|  |   | 125  | 235 | 256 | 277 | 298 | 319 | 340 | 359 | 379 | 398 | 422 | 446 | 470 | 494 |
|  |   | 121  | 233 | 254 | 275 | 296 | 317 | 338 | 357 | 377 | 396 | 420 | 444 | 468 | 492 |
|  |   | 117  | 231 | 252 | 273 | 294 | 315 | 336 | 355 | 375 | 394 | 418 | 442 | 466 | 490 |
|  |   | 113  | 229 | 250 | 271 | 292 | 313 | 334 | 353 | 373 | 392 | 416 | 440 | 464 | 488 |
|  |   | 109  | 227 | 248 | 269 | 290 | 311 | 332 | 351 | 371 | 390 | 414 | 438 | 462 | 486 |
| 105  | 225                                       | 246  | 267 | 288 | 309 | 330 | 349 | 369 | 388 | 412 | 436 | 460 | 484 |     |     |

Table 7-15 Refrigerant charge for H/P system

| 60<br>Heating Mode<br>Mode<br>De Chauffage |   | Heating Charge Chart/Tableau De Charge de Chauffage                            |     |     |     |     |     |     |     |     |     |     |     |     |  |
|--|---|--|-----|-----|-----|-----|-----|-----|-----|-----|-----|-----|-----|-----|--|
|  |   | Indoor Dry Bulb Temperature(oF)/Temperature Interieur au Themometre sec(en oF) |     |     |     |     |     |     |     |     |     |     |     |     |  |
|  |   | 60   | 62  | 64  | 66  | 68  | 70  | 72  | 74  | 76  | 78  | 80  | 82  |     |  |
|  |   | High Pressure Service Port(psig)/Vanne Détecté de Pression Haute(en psig)      |     |     |     |     |     |     |     |     |     |     |     |     |  |
| Low Pressure Service Port(psig)            | Vanne Détectée de Pression Basse(en psig) | 135  | 431 | 439 | 447 | 455 | 463 | 471 | 479 | 487 | 495 | 503 | 511 | 518 |  |
|  |   | 128  | 405 | 413 | 421 | 429 | 436 | 444 | 452 | 460 | 468 | 475 | 483 | 490 |  |
|  |   | 121  | 379 | 387 | 395 | 402 | 410 | 417 | 425 | 433 | 440 | 448 | 455 | 462 |  |
|  |   | 114  | 354 | 361 | 368 | 376 | 383 | 391 | 398 | 405 | 413 | 420 | 428 | 435 |  |
|  |   | 107  | 328 | 335 | 342 | 349 | 357 | 364 | 371 | 378 | 385 | 393 | 400 | 407 |  |
|  |   | 100  | 302 | 309 | 316 | 323 | 330 | 337 | 344 | 351 | 358 | 365 | 372 | 379 |  |
|  |   | 93   | 291 | 298 | 305 | 312 | 318 | 325 | 332 | 339 | 346 | 353 | 360 | 367 |  |
|  |   | 86   | 280 | 287 | 294 | 300 | 307 | 313 | 320 | 327 | 334 | 341 | 348 | 355 |  |
|  |   | 79   | 270 | 276 | 282 | 289 | 295 | 302 | 309 | 316 | 323 | 330 | 337 | 344 |  |
|  |   | 72   | 259 | 265 | 271 | 277 | 284 | 290 | 297 | 304 | 311 | 318 | 325 | 332 |  |
|  |   | 65   | 248 | 254 | 260 | 266 | 272 | 278 | 285 | 292 | 299 | 306 | 313 | 320 |  |
|  |   | 58   |     |     |     |     | 265 | 271 | 278 | 285 | 292 | 299 | 306 | 313 |  |
|  |   | 51   |     |     |     |     |     | 264 | 271 | 278 | 285 | 292 | 299 | 306 |  |
|  |   | 44   |     |     |     |     |     |     | 264 | 271 | 278 | 285 | 292 | 299 |  |
|  |   | 37   |     |     |     |     |     |     |     | 264 | 271 | 278 | 285 | 292 |  |
|  |   | 30   |     |     |     |     |     |     |     |     |     |     |     |     |  |

## 8 SYSTEM OPERATION

### 8.1 Compressor Crankcase Heater (Optional)

Refrigerant migration during the off cycle can result in a noisy start up. Add a crankcase heater to minimize refrigeration migration, and to help eliminate any start up noise or bearing “wash out”.

All heaters are located on the lower half of the compressor shell. Its purpose is to drive refrigerant from the compressor shell during long off cycles, thus preventing damage to the compressor during start-up.

At initial start-up or after extended shutdown periods, make sure the heater is energized for at least 12 hours before the compressor is started. (Disconnect switch on and wall thermostat off.)

**The crankcase heater will start up or shut down according to the following logic:**

The crankcase heater will start up when the compressor is off and T4 < 41 °F.

The crankcase heater will shut down when T4 ≥ 45 °F

In any condition, the crankcase heater will shut down when the compressor is on

### 8.2 Protection

#### 8.2.1 Protection for HP system

If sensors(T3&T4) become open-circuit or short-circuit, the compressor ,outdoor fan motor and reversing valve circuit will shut down.

**Discharge temperature protection:**

If discharge temp. is > 239°F, the compressor will shut down, If discharge temp. is < 167°F, the compressor will resume operation.

#### High pressure protection

If high pressure is >609PSIG,the compressor and the outdoor fan motor will stop running.

If high pressure is <464PSIG,the compressor and the outdoor fan motor will resume running(3 minutes delay necessary ).

#### Low pressure protection

When low pressure is <21PSIG,the compressor and the outdoor fan motor will stop running.

When low pressure is >44PSIG,the compressor and the outdoor fan motor will resume running(3 minutes delay necessary ).

In stand-by status, if low pressure protection was detected, the compressor will not start.

If protection cycles occur four times within 30 minutes, the compressor and outdoor fan will shut down. In this condition, the system needs to power on once more in order to keep on working.

#### T4 function:

When T4 is < 5 °F, the compressor will stop. If the electrical heater kit is installed in the indoor unit, the outdoor unit will send the operation signal to the indoor unit.

When T4 is > 10.4 °F, the compressor will restart .

### 8.3 Defrost Mode Introduction (Heat Pump Only)

#### Manual defrost mode

To manually cycle the defrost mode, set switch SW3-1 to the “ON” position (See Fig 8-1). The system will engage a defrost cycle, and automatically exit defrost mode once the Shut-down conditions of defrost mode described below are met.

Caution: Once the manual defrost mode is finished, please set switch SW3-1 back to “OFF”.

### Start-up conditions of defrost mode

When SW3-1 switch is set to "ON"(See Fig 8-1), the system will perform a defrost cycle in any of the following conditions:

1. If the compressor is operating and T3 is < 32 °F, the system will perform a defrost cycle every 30 minutes of operation.
2. If the compressor is operating and T4 is < 37.4 °F, the system will perform a defrost cycle every 30 minutes of operation.
3. When T3 is < 28.4 °F and the compressor is operating for the first time after being connected power, the system will perform a defrost after 15 minutes for the first time.
4. When T3 is < 28.4 °F and the system has been in standby for two hours, the system will perform a defrost after 15 minutes for the first time.



Fig.8-1 SW3 Switch Location in the PCB Board (For reference only)

|  |       |     |                          |
|--|-------|-----|--------------------------|
|  | SW3-1 | ON  | MANUAL DEFROST           |
|  |       | OFF | AUTOMATIC DEFROST *      |
|  | SW3-2 | ON  | RESERVED                 |
|  |       | OFF | NORMAL DEFROST *         |
|  | SW3-3 | ON  | DEFROSTING CYCLE:30MIN   |
|  |       | OFF | DEFROSTING CYCLE:60MIN * |

When SW3-1 switch is set to "OFF"(See in Fig 11), the system will perform a defrost cycle in any of the following conditions:

1. If the compressor is operating and T3 is < 32 °F, the system will perform a defrost cycle every 60 minutes of operation.
2. If the compressor is operating and T4 is < 37.4 °F, the system will perform a defrost cycle every 60 minutes of operation.
3. When T3 is < 28.4 °F and the compressor is operating for the first time after being connected power, the system will perform a defrost after 15 minutes for the first time.
4. When T3 is < 28.4 °F and the system has been in standby for two hours, the system will perform a defrost after 15 minutes for the first time.

### Shut-down conditions of defrost mode:

No matter what defrost mode is selected, the defrost cycle will end in any of the following conditions:

1. The defrost cycle has been running for 10 minutes;
2. T3 is ≥ 64.4°F for more than 60s;
3. The compressor stops operating.

## 8.4 Thermostat Signals

Table 8-1: Thermostat Signals

| Signal              | State | Board Function  |
|---------------------|-------|---|
| G                   | ON    | Blower instant ON   |
|                     | OFF   | Blower 90 sec. delay OFF  |
| G & W1              | ON    | Blower instant ON<br>Heater bank 1 elec.onstant ON  |
|                     | OFF   | Heater bank 1 elec.instant OFF<br>Blower 90 sec. delay OFF  |
| G & W & W2          | ON    | Blower instant ON<br>Heater 1 instant ON<br>Heater 2 instant ON   |
|                     | OFF   | Blower 90 sec. delay OFF<br>Heater 1 instant OFF<br>Heater 2 instant OFF  |
| G & Y               | ON    | Blower instant ON<br>Compressor and outdoor fan instant ON  |
|                     | OFF   | Compressor and outdoor fan instant OFF<br>Blower fan delay 90 sec. OFF  |
| G & B & Y           | ON    | 4-way valve instant ON<br>Blower instant ON<br>Compressor and outdoor fan instant ON  |
|                     | OFF   | Compressor and outdoor fan instant OFF<br>Blower fan delay 90 sec. OFF<br>4-way valve instant OFF   |
| G & B & Y & W1      | ON    | 4-way valve instant ON<br>Blower instant ON<br>Compressor and outdoor fan instant ON<br>Heater 1 instant ON                                       |
|                     | OFF   | 4-way valve instant OFF<br>Blower fan delay 90 sec. OFF<br>Compressor and outdoor fan instant OFF<br>Heater 1 instant OFF                         |
| G & B & Y & W1 & W2 | ON    | 4-way valve instant ON<br>Blower instant ON<br>Compressor and outdoor fan instant ON<br>Heater 1 instant ON<br>Heater 2 instant ON                |
|                     | OFF   | 4-way valve instant OFF<br>Blower fan delay 90 sec. OFF<br>Compressor and outdoor fan instant OFF<br>Heater 1 instant OFF<br>Heater 2 instant OFF |

Table 8-2: Thermostat Wire Color

| Thermostat Wire Color | Function               |
|-----------------------|------------------------|
| Red                   | Power wire             |
| Black                 | Power wire             |
| White                 | Heater signal 1        |
| Green                 | Blower fan signal      |
| Yellow                | Compressor signal      |
| Blue                  | Reversing valve signal |
| White/Black           | Heater signal 2        |

## 9 OPERATION CHECK-UP

### • Cooling Startup

1. Turn thermostat to OFF and turn power to ON
2. Turn ON thermostat and set as high as possible
3. Turn Fan switch ON and indoor blower should run
4. Turn fan switch to AUTO, system switch to COOL and thermostat temperature setting below room temperature.

Unit should run in COOLING mode.

### • Heating Startup

After normal cooling run

1. Turn thermostat switch to HEAT. After unit stops, wait about 5 minutes.
2. Turn thermostat setting above room temperature. Unit should run in HEATING mode.

After unit has run for a while, check the following:

1. Are fans running properly?
2. Is compressor running correctly?
3. Check refrigerant charge.
4. Check duct connection for leaks.
5. Check for tubing and sheet metal rattles.

(See Wiring Diagram for electric connection detail.)











## 10 TROUBLE SHOOTING

### WARNING







Component trouble shooting requires opening control box with power on.

Use extreme care while working on this condition. Check nameplate and this instruction when making wire connections.

### 10.1 Fault Code of Motor Driver Module

| LED1 ERROR CODE  | CONTENT                                      |
|--|--|
|  STEADY ON      | NORMAL OPERATION                             |
|  OFF            | POWER SUPPLY FAILURE                         |
|  KEEP FLASHING  | 2s ON<br>2s OFF<br>0.2s ON<br>0.2s OFF       |
|  | STANDBY                                      |
|  1FLASH/CYCLE   | INTER INTEGRATED CIRCUIT COMMUNICATION ERROR |
|  2FLASH/CYCLE   | MOTOR CURRENT ERROR                          |
|  3FLASH/CYCLE   | INVERTER MODULE TEMPERATURE ERROR            |
|  4FLASH/CYCLE   | DC BUS VOLTAGE ERROR                         |
|  5FLASH/CYCLE  | MOTOR PARAMETER ERROR                        |
|  6FLASH/CYCLE | MOTOR STARTUP FAILURE                        |
|  6FLASH/CYCLE | PHASE SEQUENCE ERROR                         |

### 10.2 Fault Code of Main Control Module

| LED2 ERROR CODE  | CONTENT              |
|--|----------------------|
|  STEADY ON    | NORMAL OPERATION     |
|  OFF          | POWER SUPPLY FAILURE |
|  1FLASH/CYCLE | T3 SENSOR FAILURE    |
|  2FLASH/CYCLE | T4 SENSOR FAILURE    |
|  3FLASH/CYCLE | LPC OPEN             |
|  5FLASH/CYCLE | OFM FAILURE          |
|  6FLASH/CYCLE | NO MACHINE TYPE      |









CPH SEER2\_20230214